

A man with a full beard and a brown beanie is playing an acoustic guitar. He is wearing a white t-shirt and dark blue jeans. The guitar is a light-colored acoustic with a dark pickguard. In the background, another acoustic guitar is visible, slightly out of focus. The overall scene is a close-up, artistic shot of a musician playing.

*Ibanez*

2011 Acoustic Guitars



## Discover your Voice, Tone, Style

Performers have always felt a strong affinity for the acoustic guitar because of its ability to translate the full range of a player's emotions into a sound that touches both the listener and performer. The world today contains an abundance of musical styles and fashions, and people's tastes regarding guitars are no less varied - from traditional models that have remained unchanged for decades to fashionable models that come in a variety of colors. Different musical forms, performance situations, and player ages give rise to a diverse array of needs on the part of musicians.

Ibanez takes pride in the fact that our 2011 line of acoustic guitars answers these demands. This doesn't mean we are blindly following the latest trends. For our 2011 reimagining of the Artwood series, we have added a modern sensibility while respecting tradition. The Artwood series will satisfy the player looking for a standard acoustic guitar and supply them with the extraordinary tone produced by high-quality woods.

At the same time, all of our acoustic guitars feature the attractive body shapes and specifications that Ibanez has always provided. The AEF series and Montage series both come in a beautiful range of colors while an extensive array of the EW (Exotic Wood) series gives you a large choice in a variety of precious woods.

The common thread found in each series is a design and sound that transmits the exhilaration and enjoyment of performance and provides players with value that goes far beyond expectations.

Just as no two guitars sound the same, no two players have quite the same tone. Every guitarist possesses a distinct sound that comes from the guitar they play coupled with their singular personality. Ibanez wants nothing more than to produce acoustic guitars that allow players to truly express the music inside them.

## Table of Contents

Artwood	4-9	V	32
AEF	10-12	SAGE	33-36
AEL	13-15	GA	37
AEG	16-17	MANDOLIN	38-39
AEB	18-19	DT	39
EXOTIC WOODS	20-23	UKULELE	40-41
JOE SATRIANI	24	Jam Packs	42-43
STEVE VAI	25	Amplifiers	44
MONTAGE	26-27	Cases, Bags & Accessories	45
TALMAN	28-29	FEATURES & ELECTRONICS	46-47
PF	30-31		



# AW Artwood

## AW Features

- Dovetail Neck Joint at 14th Fret
- Solid Top
- Mahogany Neck
- Rosewood Bridge and Fretboard
- Bone Nut and Saddle
- Ibanez Advantage™ Bridge Pins
- Low-Gloss Neck Finish
- D'Addario® EXP™ Strings



### AW3000WCNT

- Dreadnought Body
- Solid Engelmann Spruce Top
- Solid Mahogany Back and Sides
- Abalone Fretboard Inlay
- Rosewood Neck and Body Binding
- Abalone Rosette
- Gold Grover® Tuners with Brown Pearloid Knobs
- Natural High Gloss Finish

*\*INCLUDES LIGHTWEIGHT DREADNOUGHT CASE*

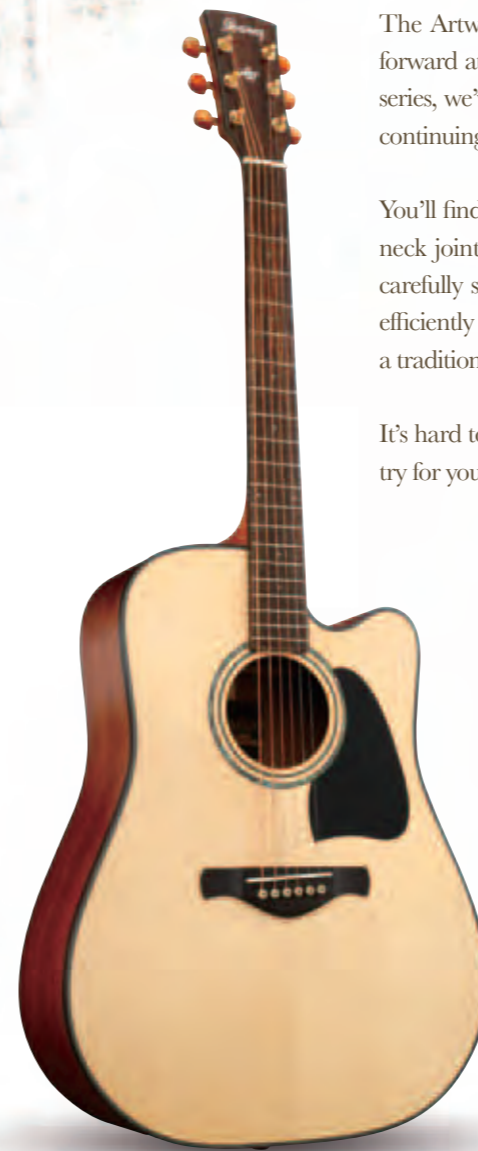

### AW3000CEWCNT

- Dreadnought Body with Cutaway
- Solid Engelmann Spruce Top
- Solid Mahogany Back and Sides
- LR Baggs® Element™ Pickup
- LR Baggs® EAS-VTC™ Preamp
- Abalone Fretboard Inlay
- Rosewood Neck and Body Binding
- Abalone Rosette
- Gold Grover® Tuners with Brown Pearloid Knobs
- Natural High Gloss Finish

*\*INCLUDES LIGHTWEIGHT DREADNOUGHT CASE*

*LR Baggs*



The Artwood series was crafted to produce a traditional as well as a modern guitar. Technology moves forward at a frantic pace and the world of guitar craftsmanship is no different. In producing the Artwood series, we've respected the rich tradition of the acoustic guitar while adding modern interpretations in our continuing search for the ultimate in guitar tone.

You'll find traditional specifications common to each model, such as a bone nut and saddle and a dovetail neck joint, as well as a neck shape that provides an easy grip. Rich tone and big sound come from the carefully selected high-quality wood used to construct the guitar. The modern design of the bridge shape efficiently transmits vibration and the simple yet elegant aesthetic touches fuse a modern design sense with a traditional feel.

It's hard to describe the warm tones and overall quality of the Artwood Series. It's an experience you must try for yourself. We invite you to take a closer look at the new 2011 Artwood series.



### AC3000WCNT

- Grand Concert Body
- Solid Engelmann Spruce Top
- Solid Mahogany Back and Sides
- Abalone Fretboard Inlay
- Rosewood Neck and Body Binding
- Abalone Rosette
- Gold Grover® Tuners with Brown Pearloid Knobs
- Natural High Gloss Finish

*\*INCLUDES LIGHTWEIGHT GRAND CONCERT CASE*

### AW3080WCNT

- Dreadnought Body
- Solid Engelmann Spruce Top
- Solid Indian Rosewood Back and Sides
- Abalone Fretboard Inlay
- Mahogany Neck and Body Binding
- Abalone Rosette
- Gold Grover® Tuners with Brown Pearloid Knobs
- Natural High Gloss Finish

*\*INCLUDES LIGHTWEIGHT DREADNOUGHT CASE*

### LR Baggs® Element™ Pickup and EAS-VTC™ Preamp with Soundhole Mounted Tone and Volume Control

The AW3000CE feature the EAS-VTC™ Preamp – an LR Baggs® element™ pickup that includes volume and tone control. The all-discrete class A endpin preamp provides a natural bass sound for a wide variety of tone. A soundhole mounting provides excellent operability, ensuring very little alteration of the body, so the natural sound of the guitar is always pristine.



**AW300**

- Dreadnought Body
- Solid Engelmann Spruce Top
- Mahogany Back and Sides
- Abalone Rosette
- Chrome Grover® Tuners



**AW300DVS**  
Dark Violin Sunburst  
High Gloss Finish

**AW300NT**  
Natural High Gloss Finish

**AW300VS**  
Vintage Sunburst  
High Gloss Finish

# AW

## AW Features

- Dovetail Neck Joint at 14th Fret
- Solid Top
- Mahogany Neck
- Rosewood Bridge and Fretboard
- Bone Nut and Saddle
- Ibanez Advantage™ Bridge Pins
- Low-Gloss Neck Finish
- D'Addario® EXP™ Strings

### AW300LNT

- Left-Handed
- Natural High Gloss Finish



### AC300NT

- Grand Concert Body
- Solid Engelmann Spruce Top
- Mahogany Back and Sides
- Abalone Rosette
- Chrome Grover® Tuners
- Natural High Gloss Finish

### AW250RTB

- Dreadnought Body
- Solid Cedar Top
- Mahogany Back and Sides
- Wooden Rosette
- Chrome Grover® Tuners
- Rustic Brown Low Gloss Finish

### AC240OPN

- Grand Concert Body
- Solid Mahogany Top
- Mahogany Back and Sides
- Abalone Rosette
- Chrome Grover® Tuners
- Open Pore Natural Finish



AW series feature Grover® Tuners with Bone nut



**AW bridge with Bone saddle**  
The AW bridge includes a bone saddle that delivers a well-balanced sound.



### AW380ECENT

- Dreadnought Body with Cutaway
- Solid Engelmann Spruce Top
- Rosewood Back and Sides
- Abalone Rosette
- Chrome Grover® Tuners
- Fishman® Sonicore Pickup
- Ibanez SST Shape Shifter™ Preamp with Onboard Tuner
- Balanced 1/4" and XLR Outputs
- Natural High Gloss Finish



### AC350ECENT

- Grand Concert Body with Cutaway
- Solid Cedar Top
- Mahogany Back and Sides
- Abalone Rosette
- Chrome Grover® Tuners
- Fishman® Sonicore Pickup
- Ibanez SST Shape Shifter™ Preamp with Onboard Tuner
- Balanced 1/4" and XLR Outputs
- Natural High Gloss Finish



### AC300ECENT

- Grand Concert Body with Cutaway
- Solid Engelmann Spruce Top
- Mahogany Back and Sides
- Abalone Rosette
- Chrome Grover® Tuners
- Fishman® Sonicore Pickup
- Ibanez SST Shape Shifter™ Preamp with Onboard Tuner
- Balanced 1/4" and XLR Outputs
- Natural High Gloss Finish



### AW250ECERTB

- Dreadnought Body with Cutaway
- Solid Cedar Top
- Mahogany Back and Sides
- Wooden Rosette
- Chrome Grover® Tuners
- Fishman® Sonicore Pickup
- Ibanez SST Shape Shifter™ Preamp with Onboard Tuner
- Balanced 1/4" and XLR Outputs
- Rustic Brown Low Gloss Finish



AW300ECENT  
Natural High Gloss Finish



AW300ECEDVS  
Dark Violin Sunburst High Gloss Finish

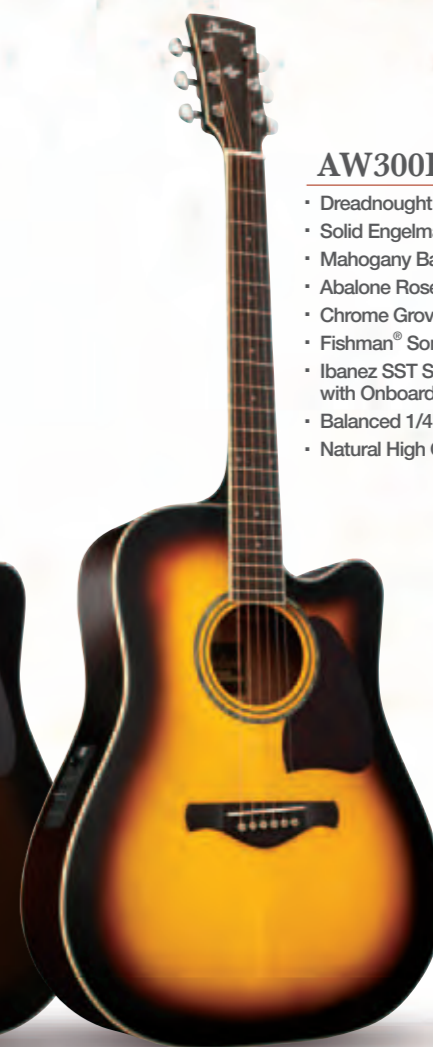

AW300ECEVS  
Vintage Sunburst High Gloss Finish

### AW300ECE

- Dreadnought Body with Cutaway
- Solid Engelmann Spruce Top
- Mahogany Back and Sides
- Abalone Rosette
- Chrome Grover® Tuners
- Fishman® Sonicore Pickup
- Ibanez SST Shape Shifter™ Preamp with Onboard Tuner
- Balanced 1/4" and XLR Outputs
- Natural High Gloss Finish

### AW300LECENT

- Left-Handed
- Natural High Gloss Finish



# AW Artwood

### AW-E Features

- Dovetail Neck Joint at 14th Fret
- Solid Top
- Mahogany Neck
- Rosewood Bridge and Fretboard
- Bone Nut and Saddle
- Ibanez Advantage™ Bridge Pins
- Low-Gloss Neck Finish
- D'Addario® EXP™ Strings



### Fishman® Sonicore Pickup and Ibanez SST Shape Shifter™ Preamp with Onboard Tuner

The powerful Fishman® Sonicore pickup, complemented by the Ibanez SST Shape Shifter™ preamp with onboard tuner, enables easy sonic manipulation using the 3-band EQ and tone shaper. Any contour is right at your fingertips. The SST also offers a phase reverse for feedback reduction.

# AEF

## AEF Features

- AEF Body
- Mahogany Neck
- Rosewood Bridge and Fretboard
- Ibanez Ivorex II™ Nut and Saddle
- Ibanez Advantage™ Bridge Pins
- D'Addario® EXP™ Strings

Back by popular demand, the improved feedback-resistant AEF body offers an ergonomic and comfortable shape. AEF models feature a large range of striking sunburst and solid finishes, quilted maple bodies, flamed maple tops and sides, and spruce tops. The AEF37E and AEF30E models feature pearl block and abalone fretboard inlays while the AEF18E offers a laser engraved fire rosette. For comfort, clear highs, and strong midrange punch, there's no acoustic guitar that gets it all done at such an affordable price.



### AEF37E

- Quilted Maple Top
- Quilted Maple Back and Sides
- Abalone Rosette
- Abalone/Pearloid Block Fretboard Inlay
- Ibanez Gold Die-Cast Tuners
- Fishman® Sonicore Pickup
- Ibanez SST Shape Shifter™ Preamp with Onboard Tuner
- Balanced 1/4" and XLR Outputs

**AEF37ETCS**  
Transparent Black Cherry Sunburst  
High Gloss Finish

**AEF37ETES**  
Transparent Emerald Sunburst  
High Gloss Finish



**AEF30ETBS**  
Transparent Blue Sunburst High Gloss Finish



**AEF30ETHS**  
Transparent Hibiscus Sunburst High Gloss Finish



**AEF30ETVS**  
Transparent Violet Sunburst High Gloss Finish



**AEF30EVV**  
Vintage Violin High Gloss Finish

### AEF30E

- Flamed Maple Top
- Flamed Maple Back and Sides
- Pearloid Rosette
- Abalone/Pearloid Block Fretboard Inlay
- Ibanez Gold Die-Cast Tuners
- Fishman® Sonicore Pickup
- Ibanez SST Shape Shifter™ Preamp with Onboard Tuner
- Balanced 1/4" and XLR Outputs



**Fishman® Sonicore Pickup and Ibanez SST Shape Shifter™ Preamp With Onboard Tuner**

Designed especially to work with the Fishman® Sonicore Pickups, the Ibanez SST Preamp features a built-in tuner, 3-Band tone control, and Shape control.



**AEF18EBK**  
Black High Gloss Finish



**AEF18EDVS**  
Dark Violin Sunburst High Gloss Finish



**AEF18LENT**

- Left-handed
- Spruce Top
- Mahogany Back and Sides
- Fire Pattern Wooden Rosette
- Ibanez Chrome Die-Cast Tuners
- Ibanez Under Saddle Pickup
- Ibanez SPT Shape Shifter™ Preamp with Onboard Tuner
- Balanced 1/4" and XLR Outputs
- Natural High Gloss Finish

**AEF18E**

- Spruce Top
- Mahogany Back and Sides
- Fire Pattern Wooden Rosette
- Ibanez Chrome Die-Cast Tuners
- Ibanez Under Saddle Pickup
- Ibanez SPT Shape Shifter™ Preamp with Onboard Tuner
- Balanced 1/4" and XLR Outputs

# AEF

**AEF Series Features**

- AEF Body
- Mahogany Neck
- Rosewood Bridge and Fretboard
- Ibanez Ivorex II™ Nut and Saddle
- Ibanez Advantage™ Bridge Pins
- D'Addario® EXP™ Strings

**AEF1812EBK**

- 12-string
- Spruce Top
- Mahogany Back and Sides
- Fire Pattern Wooden Rosette
- Ibanez Chrome Die-Cast Tuners
- Ibanez Under Saddle Pickup
- Ibanez SPT Shape Shifter™ Preamp with Onboard Tuner
- Balanced 1/4" and XLR Outputs
- Black High Gloss Finish



# AEL

If you're looking for a guitar that has the size, projection, and a beautiful tone for any situation, the AEL is right for you. The AEL is our largest acoustic guitar body that offers both Solid Spruce and Flamed Maple Tops. AEL models feature Fishman® Sonicore pickups and Ibanez AEQ-SST Shape Shifter™ preamps that deliver a sweet cascade of acoustic tones.

**AEL30SE**

- Solid Spruce Top
- Mahogany Back and Sides
- Abalone/Pearloid Block Fretboard Inlay
- Ibanez Gold Die-Cast Tuners

**AEL30SEBK**  
Black High Gloss Finish



**AEL30SEDVS**  
Dark Violin Sunburst High Gloss Finish

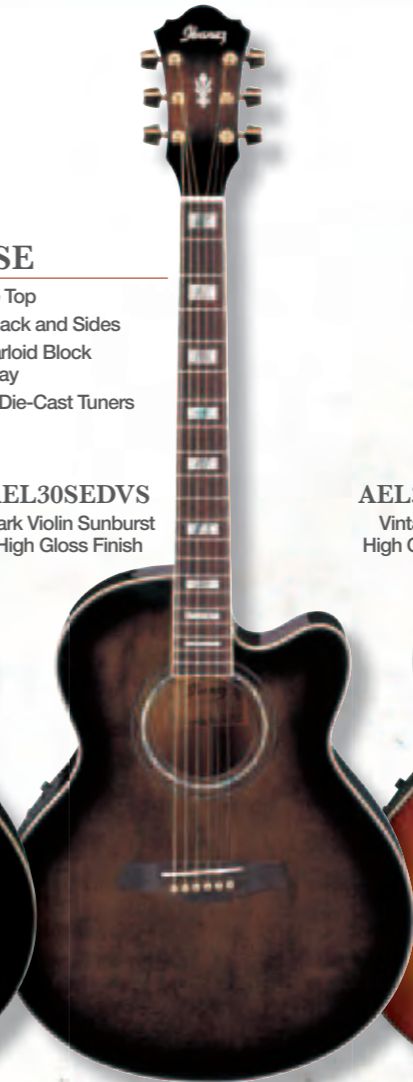

**AEL30SEVV**  
Vintage Violin High Gloss Finish



**AEL Features**

- AEL Body
- Mahogany Neck
- Abalone Rosette
- Fishman® Sonicore Pickup
- Ibanez SST Shape Shifter™ Preamp with Onboard Tuner
- Balanced 1/4" and XLR Outputs
- Rosewood Bridge and Fretboard
- Ibanez Ivorex II™ Nut and Saddle
- Ibanez Advantage™ Bridge Pins
- D'Addario® EXP™ Strings

**Fishman® Sonicore Pickup and Ibanez SST Shape Shifter™ Preamp With Onboard Tuner**



AEL30SE models feature the powerful Fishman® Sonicore pickup, complemented by the Ibanez SST Shape Shifter™ preamp with onboard tuner that easily allows you to dial in your tone. Any contour is right at your fingertips.



**Ibanez SPT Shape Shifter™ Preamp with Onboard Tuner**  
(Same as SST but made for Ibanez Under Saddle Pickup)

The Ibanez SPT preamp on the AEF18E has a 3-band tone control and shape control along with a built-in electronic tuner.

# AEL

## AEL Features

- AEL Body
- Mahogany Neck
- Abalone Rosette
- Fishman® Sonicore Pickup
- Ibanez SST Shape Shifter™ Preamp with Onboard Tuner
- Balanced 1/4" and XLR Outputs
- Rosewood Bridge and Fretboard
- Ibanez Ivorex II™ Nut and Saddle
- Ibanez Advantage™ Bridge Pins
- D'Addario® EXP™ Strings



**AEL20ETBS**  
Transparent Blue Sunburst High Gloss Finish

## AEL20E

- Flamed Maple Top
- Maple Back and Sides
- Ibanez Gold Die-Cast Tuners



**AEL20ETRS**  
Transparent Red Sunburst High Gloss Finish



**AEL20EVV**  
Vintage Violin High Gloss Finish



## AEL10LEBK

- Left-handed
- Spruce Top
- Mahogany Back and Sides
- Ibanez Chrome Die-Cast Tuners
- Black High Gloss Finish



**AEL20ETKS**  
Transparent Black Sunburst High Gloss Finish



## AEL2012ETKS

- 12-string
- Flamed Maple Top
- Maple Back and Sides
- Ibanez Gold Die-Cast Tuners
- Transparent Black Sunburst High Gloss Finish

## Fishman® Sonicore Pickup and Ibanez SST Shape Shifter™ Preamp With Onboard Tuner



Not just a pretty face: AEL20E and AEL10E models feature Fishman® Sonicore pickups and Ibanez SST Shape Shifter™ preamps with onboard tuners for sophisticated tones and effortless tuning.



# AEG

The AEG Series' slender, single-cutaway bodies deliver powerful and balanced acoustic sound, unplugged or through an amp or PA system. These guitars combine easy playability, classic solid and sunburst finishes and mahogany bodies with spruce or quilted maple tops to create a quality, workhorse acoustic guitar that will rise to any occasion. High quality Fishman® Sonicore pickups and Ibanez SST Shape Shifter™ preamps with onboard tuners provide the sparkling tones that sound great in any venue.

## AEG Features

- AEG Body
- Mahogany Neck
- Abalone Rosette
- Fishman® Sonicore Pickup
- Ibanez SST Shape Shifter™ Preamp with Onboard Tuner
- Balanced 1/4" and XLR Outputs
- Rosewood Bridge and Fretboard
- Ibanez Ivorex II™ Nut and Saddle



**AEG10NEBK**  
Black Flat Finish



## AEG10NE

- 14th Fret Neck/Body Joint
- Nylon Strings
- Spruce Top
- Mahogany Back and Sides
- Gold Classical Tuners

**AEG10NETNG**  
Tangerine High Gloss Finish



## AEG25E

- Quilted Maple Top
- Mahogany Back and Sides
- Ibanez Chrome Die-Cast Tuners
- Ibanez Advantage™ Bridge Pins

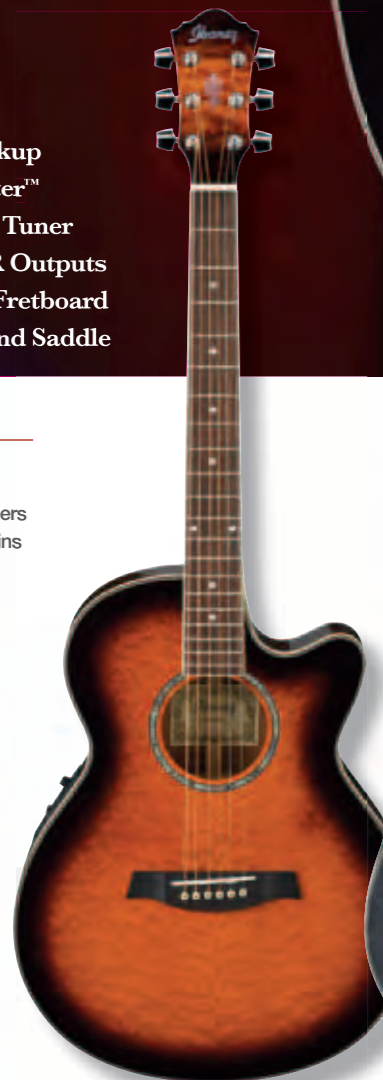

**AEG25EBS**  
Brown Sunburst  
High Gloss Finish



**AEG25ETBK**  
Transparent Black  
High Gloss Finish



**AEG25ETRD**  
Transparent Red  
High Gloss Finish

## AEG10E

- Spruce Top
- Mahogany Back and Sides
- Ibanez Chrome Die-Cast Tuners
- Ibanez Advantage™ Bridge Pins



**AEG10EBK**  
Black High Gloss Finish



**AEG10ETBS**  
Transparent Blue Sunburst  
High Gloss Finish



**AEG10EVS**  
Vintage Sunburst  
High Gloss Finish



## Fishman® Sonicore Pickup and Ibanez SST Shape Shifter™ Preamp With Onbord Tuner

The powerful Fishman® Sonicore Pickup, complemented by the Ibanez SST Shape Shifter™ preamp with onboard tuner, enables easy sonic manipulation using the 3-band EQ and tone shaper. Any contour is right at your fingertips. The SST also offers a phase reverse for feedback reduction.

# AEB

The addition of an acoustic bass in any musical situation adds a layer of warm, low-end resonance that makes songs come alive. The AEB full-sized body provides rich tones while the 32" neck scale offers the right combination of tonal warmth, easy playability and clear articulation.



**AEB10EBK**  
Black High Gloss Finish



**AEB10EDVS**  
Dark Violin Sunburst High Gloss Finish



**AEB10ENT**  
Natural High Gloss Finish

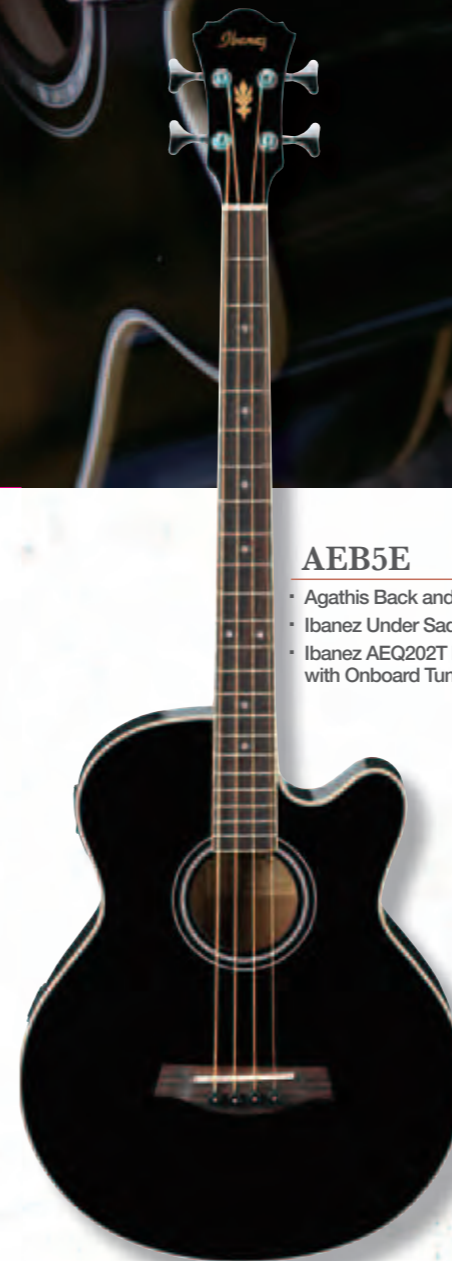

**AEB5EBK**  
Black High Gloss Finish

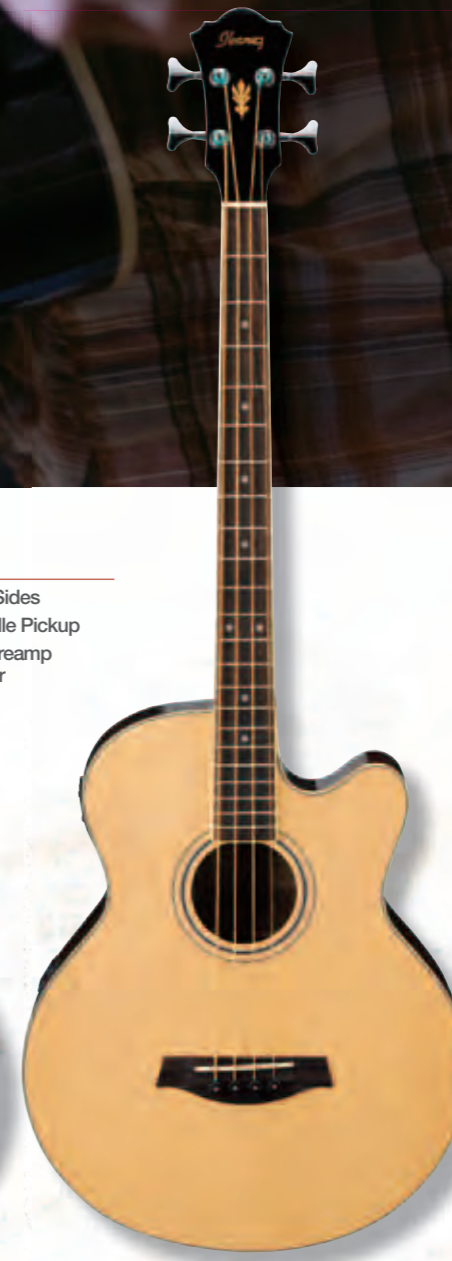

**AEB5ENT**  
Natural High Gloss Finish

## AEB10E

- Mahogany Back and Sides
- Abalone Rosette
- Fishman® Sonicore Pickup
- Ibanez SST Shape Shifter™ Preamp with Onboard Tuner
- Balanced 1/4" and XLR Outputs

## AEB5E

- Agathis Back and Sides
- Ibanez Under Saddle Pickup
- Ibanez AEQ202T Preamp with Onboard Tuner

## AEB Features

- 32" Scale
- AEB Body
- Spruce Top
- Mahogany Neck
- Chrome Die-Cast Tuners
- Rosewood Bridge and Fretboard
- Ibanez Ivorex II™ Nut and Saddle

### Fishman® Sonicore Pickup and Ibanez SST Shape Shifter™ Preamp with Onboard Tuner

Bring on the low end: AEB10E models feature Fishman® Sonicore pickups and Ibanez SST Shape Shifter™ preamps with onboard tuners for natural-sounding bass tones.



### Ibanez AEQ 202T Preamp with Onboard Tuner

The AEB5E models feature an Ibanez under saddle pickup and Ibanez AEQ202T preamp with 2-band EQ and onboard tuner.

# EW

The universally-praised EW Series pairs gorgeous and exotic tone woods such as Monkey Pod, Spalted Mango and Burl Maple with the fantastic combo of B-Band® UST™ pickups and Ibanez SRTc preamps with chorus and onboard tuners, creating instruments that are pleasing to both the eye and the ear.



## EW50MPSENT

- Solid Monkey Pod Top
- Monkey Pod Back & Sides
- Pearl Rosette
- Rosewood Neck and Body Binding
- Ibanez Gold Die-Cast Tuners with Brown Pearloid Knobs
- Ebony Bridge and Fretboard
- Natural High Gloss Finish

## EW20SGENT

- Spalted Mango Body
- Abalone Rosette
- Ibanez Chrome Die-Cast Tuners
- Rosewood Bridge and Fretboard
- Natural High Gloss Finish

## EW20MBENT

- Burl Maple Body
- Abalone Rosette
- Ibanez Chrome Die-Cast Tuners
- Rosewood Bridge and Fretboard
- Natural High Gloss Finish

## EW2012ASENT

- 12-string
- Figured Ash Body
- Abalone Rosette
- Ibanez Chrome Die-Cast Tuners
- Rosewood Bridge and Fretboard
- Natural High Gloss Finish

### EW Features

- EW Body with Cutaway
- Mahogany Neck
- B-Band® UST™ Pickup
- Ibanez SRTc Preamp with Chorus and an Onboard Tuner
- Balanced 1/4" and XLR Outputs
- Ibanez Ivorex II™ Nut and Saddle
- Ibanez Advantage™ Bridge Pins
- D'Addario® EXP™ Strings

### B-BAND® UST™ Pickup and Ibanez SRTc Preamp with Chorus, Variable Phase Reverse, and Onboard Tuner

The biggest advantage on the Ibanez SRTc preamp is that you can instantly get beautiful chorus sound with the push of one button.



## EW20QMENT

- Quilted Maple Body
- Abalone Rosette
- Ibanez Chrome Die-Cast Tuners
- Rosewood Bridge and Fretboard
- Natural High Gloss Finish

## EW20ZWENT

- Zebra Wood Body
- Abalone Rosette
- Ibanez Chrome Die-Cast Tuners
- Rosewood Bridge and Fretboard
- Natural High Gloss Finish

## EW20ASENT

- Figured Ash Body
- Abalone Rosette
- Ibanez Chrome Die-Cast Tuners
- Rosewood Bridge and Fretboard
- Natural High Gloss Finish

## EW20LASENT

- Left-Handed
- Figured Ash Body
- Abalone Rosette
- Ibanez Chrome Die-Cast Tuners
- Rosewood Bridge and Fretboard
- Natural High Gloss Finish



# EWC

The EWC Series features a body that's smaller and shallower than the original EW's, but no less tuneful. EWC's combine woods like Ebony and Figured Ash with the same high-quality electronics as the larger EW series.



## EWC30EBENT

- Ebony Body
- Mahogany Neck and Body Binding
- Natural High Gloss Finish

## EWC30ASERLG

- Figured Ash Body
- Mahogany Neck and Body Binding
- Resonant Low Gloss Finish

## EWC Features

- Mini EW Body with Cutaway
- Mahogany Neck
- Abalone Rosette
- Ibanez Chrome Die-Cast Tuners
- B-Band® UST™ Pickup
- Ibanez SRTc Preamp with Chorus and an Onboard Tuner
- Balanced 1/4" and XLR Outputs
- Rosewood Bridge and Fretboard
- Ibanez Ivorex II™ Nut and Saddle
- Ibanez Advantage™ Bridge Pins
- D'Addario® EXP™ Strings

## B-BAND® UST™ Pickup and Ibanez SRTc Preamp with Chorus, Variable Phase Reverse, and Onboard Tuner

The biggest advantage on the Ibanez SRTc preamp is that you can instantly get beautiful chorus sound with the push of one button.

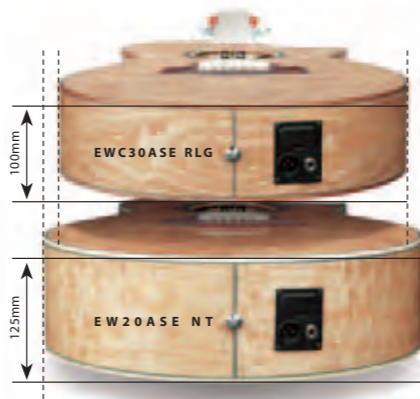

## EWC Body

The EWC's relatively compact body offers more comfortable playability.

# EWN

The Ibanez EWN Nylon-string series brings together comfortable nylon strings, thinner necks than standard classical guitars and beautiful flamed sycamore, koa and bubinga to create instruments that feel and play like the smoothest classical guitar you've ever held.

## EWN Features

- Nylon Strings
- Thinline Mini EW Body with Cutaway
- 14th Fret Neck/Body Joint
- Mahogany Neck
- Mahogany Neck and Body Binding
- Laser-Engraved Wood Rosette
- Gold Classical Tuners
- B-Band® UST™ Pickup
- Ibanez SRTc Preamp with Chorus and an Onboard Tuner
- Balanced 1/4" and XLR Outputs
- Rosewood Bridge and Fretboard
- Ibanez Ivorex II™ Nut and Saddle
- D'Addario® EXP™ Classical Strings



## EWN28KOENT

- Koa Body
- Natural High Gloss Finish

## EWN28BGENT

- Bubinga Body
- Natural High Gloss Finish

## EWN28SYENT

- Flamed Sycamore Body
- Natural High Gloss Finish

# EWB

The Exotic Wood basses, like the rest of the EW Series, combine beauty in craftsmanship and pro electronics to create an acoustic bass that sounds as good as it looks. The EWB basses feature a 34" scale neck for clear articulation and the 5-string EWB205WNENT is available for players who desire the extended range of a low-B string.



## EWB20WNENT

- 4-string Bass
- Natural High Gloss Finish

## EWB205WNENT

- 5-string Bass
- Natural High Gloss Finish

## EWB Features

- 34" Scale Neck
- EW Body with Cutaway
- Cordia Body
- Mahogany Neck
- Abalone Rosette
- Chrome Die-Cast Tuners
- Fishman® Sonicore Pickup
- Ibanez SRTc Preamp with Chorus and an Onboard Tuner
- Balanced 1/4" and XLR Outputs
- Rosewood Bridge and Fretboard
- Ibanez Ivorex II™ Nut and Saddle
- D'Addario® EXP™ Strings



"I've been playing the JSA acoustic onstage and it feels great, plays great and sounds wonderful. And, in all black, it looks so cool! It has outstanding projection, and an impressive dynamic range too, with a powerful clear tone essential for live performance. The JSA acoustic has a full and balanced sound that's perfect for strumming, soloing, or delicate finger picking. It has good access to the upper frets, and the electronics make anything you play sound clear and natural."

# JSA

Joe Satriani  
Signature



### Fishman® Acoustic Matrix™ Pickup with Ellipse® VT Preamp

JSA10 features the Fishman® Matrix™ pickup with Ellipse® VT preamp. The ergonomic soundhole-mounted design puts slider controls at your fingertips, to maintain a natural playing position. Plus, the unique tone control cuts mid ranges while boosting treble and bass.

**FISHMAN®**



### JSA10-BK

- Solid Engelmann Spruce Top
- Solid Rosewood Back and Sides
- Abalone Body Binding
- Mahogany Neck
- Fishman® Acoustic Matrix™ Pickup
- Fishman® Ellipse® VT Preamp
- Chrome Grover® Tuners
- Abalone Rosette
- Ebony Bridge & Fretboard
- TUSQ® Compensated Saddle
- D'Addario® EXP™ Strings
- Black High Gloss Finish



### JSA5-BK

- Solid Engelmann Spruce Top
- Mahogany Back and Sides
- Mahogany Neck
- Fishman® Sonicore Pickup
- Fishman® Presys™ Preamp with Onboard Tuner
- Chrome Grover® Tuners
- Abalone Rosette
- Rosewood Bridge & Fretboard
- D'Addario® EXP™ Strings
- Black High Gloss Finish

### Fishman® Sonicore Pickup with Fishman® Presys™ Preamp

JSA5 features Fishman® Sonicore pickup with Presys™ preamp. Its compact, sophisticated Presys™ system features volume, bass, mid and treble controls, a phase switch, and a built-in tuner with LED display. The unique design allows easy battery access.



# Steve Vai Signature Euphoria

"The new Euphoria is made to be sleek and thin with a large acoustic electric sound. Its size gives it a bright crisp tone that allows it to sit on top of a mix."



### Fishman® Acoustic Matrix™ Undersaddle Pickup with Aura® IC

The EP10 includes a Fishman® Matrix™ Undersaddle Pickup that features the amazing Aura® Image Casting (IC) Technology. The system comes with four Aura® IC images created specifically for Steve. Aura® Image Casting Electric (ICE)

Technology was used to create four ethereal and rich acoustic tones. Each image was generated using a full body guitar, top-shelf microphones and an undersaddle pickup in a professional recording environment. The EP10 is also fitted with a compact preamp with simple volume and tone controls that are just right for a lightweight and thin body performance guitar.

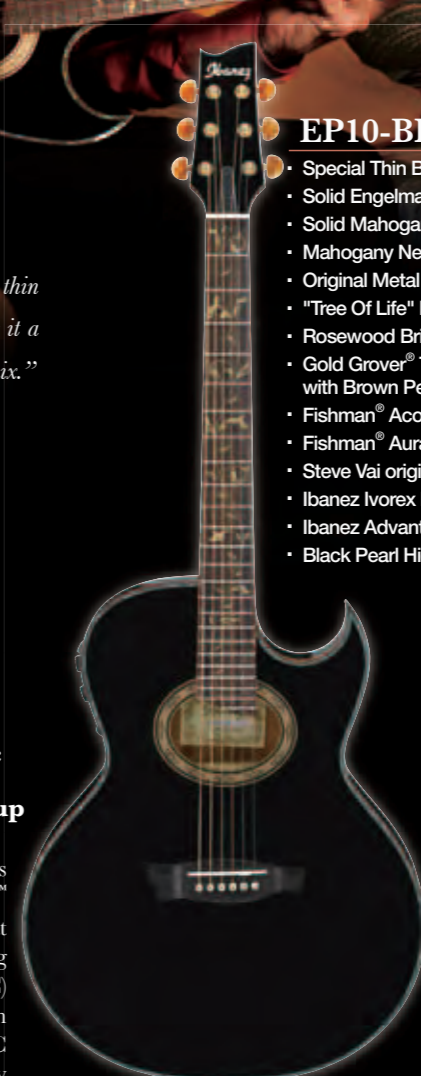

### EP10-BP

- Special Thin Body
- Solid Engelmann Spruce Top
- Solid Mahogany Back and Sides
- Mahogany Neck
- Original Metal Plate Rosette
- "Tree Of Life" Fretboard Inlay
- Rosewood Bridge and Fretboard
- Gold Grover® Tuners with Brown Pearloid Knobs
- Fishman® Acoustic Matrix™ Pickup
- Fishman® Aura® IC Preamp
- Steve Vai original pre set sound
- Ibanez Ivorex II™ Nut and Saddle
- Ibanez Advantage™ Bridge Pins
- Black Pearl High Gloss Finish

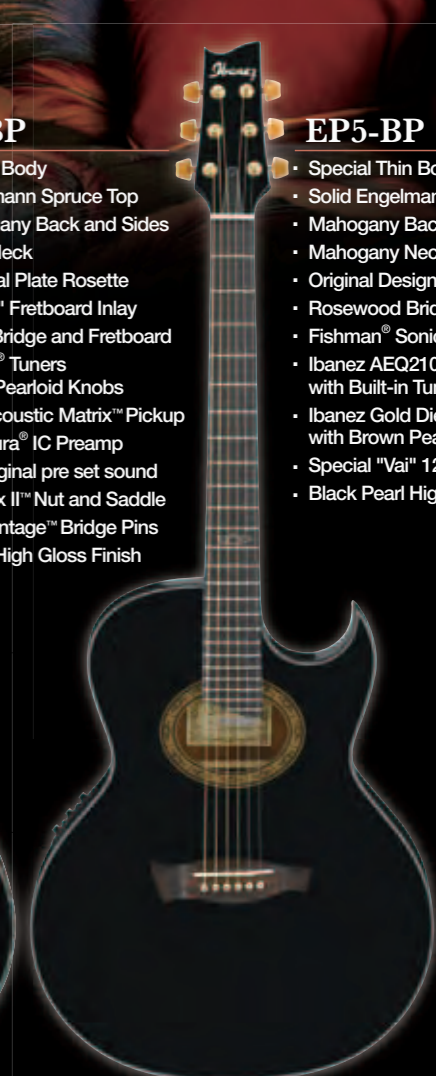

### EP5-BP

- Special Thin Body
- Solid Engelmann Spruce Top
- Mahogany Back and Sides
- Mahogany Neck
- Original Design Rosette
- Rosewood Bridge and Fretboard
- Fishman® Sonicore Pickup
- Ibanez AEQ210TF Preamp with Built-in Tuner
- Ibanez Gold Die-Cast Tuners with Brown Pearloid Knobs
- Special "Vai" 12th fret Inlay
- Black Pearl High Gloss Finish

### Fishman® Sonicore Pickup and Ibanez AEQ210TF Preamp

The EP5 features a Fishman® Sonicore Pickup and an Ibanez AEQ210TF preamp designed especially for thin bodies. Its simple 2-band control makes adjusting the sound easy and provides plenty of bottom. A phase switch for reducing feedback and a user-friendly onboard tuner are also provided.



# A Kaleidoscope of Sound Montage

Guitarists are often called upon to cover all sorts of sounds and textures: acoustic, electric, rhythm, lead. Unfortunately, this usually results in a car full of extra gear. Not anymore: The Montage is a complete sonic arsenal for those busy working musicians. You can get any sound, from purely clear acoustic to heavily distorted electric and everything in between, in just one guitar. Your dilemma is now no longer an issue. Just grab one Montage series guitar, and you're set for the gig.

## Montage Features

- Ibanez Original MSC Body
- Mahogany Neck
- Ibanez AP10 Magnetic Pickup and Ibanez Under Saddle Pickup
- Ibanez Original M300 Preamp with Onboard Tuner
- Rosewood Bridge and Fretboard
- Ibanez Ivorex II™ Nut and Saddle
- Ibanez Advantage™ Bridge Pins
- D'Addario® EXP™ Strings

### MSC380FMTRD

- Flamed Maple Top
- Flamed Maple Back and Sides
- Ibanez Gold Die-Cast Tuners
- Transparent Red High Gloss Finish

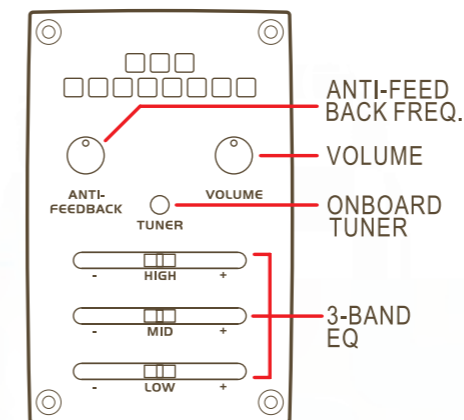

### M300 Preamp

Montage guitars feature a 3-way switch that enables you to get both acoustic and electric guitar sounds, with individual controls for both.

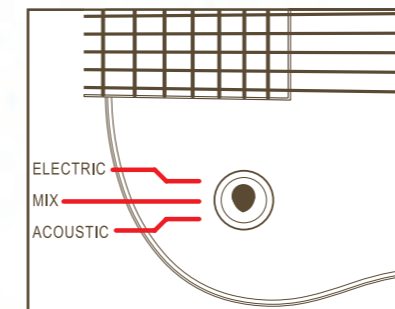
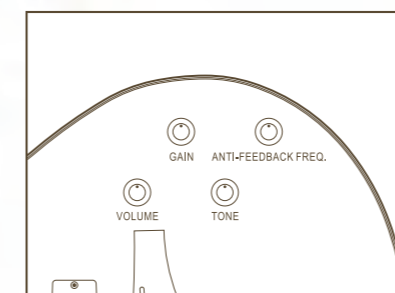

### Montage Controls

The under saddle pickup and the 3-band EQ with anti-feedback control, delivers clear acoustic tones without compromise. The magnetic pickup and gain control gives you the distorted electric guitar sound instantly.

### MSC350

- Spruce Top
- Mahogany Back and Sides
- Ibanez Chrome Die-Cast Tuners

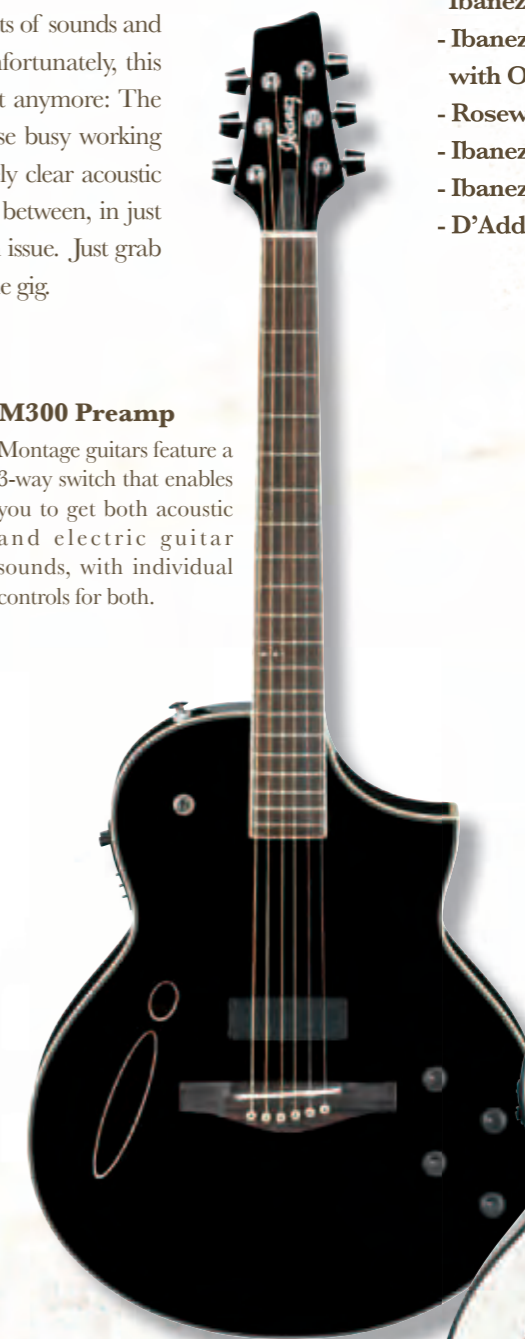

MSC350BK  
Black High Gloss Finish



MSC350PW  
Pearl White High Gloss Finish

### MSC380QMVV

- Quilted Maple Top
- Quilted Maple Back and Sides
- Ibanez Gold Die-Cast Tuners
- Vintage Violin High Gloss Finish

# Talman

Our double-cutaway Talmans are perfect for the electric guitarist who wants to gain the full tones of an acoustic guitar without losing the comfort and playability of an electric.

## Talman Features

- Talman Double Cutaway Body
- Mahogany Neck
- Rosewood Bridge and Fretboard
- Ibanez Ivorex II™ Nut and Saddle
- Ibanez Advantage™ Bridge Pins



Ibanez AP2 magnetic soundhole pickup and AEQ200M preamp with 2-Band EQ on TCM50VBS.

## TCM50VBS

- Figured Ash Top
- Mahogany Back and Sides
- Ibanez Chrome Die-Cast Tuners
- Ibanez AP2 Magnetic Pickup
- Ibanez AEQ200M Preamp with 2-Band EQ
- Vintage Brown Sunburst High Gloss Finish



TCY15ERD  
Red High Gloss Finish



TCY20EVV  
Vintage Violin High Gloss Finish



TCY20ETRS  
Transparent Red Sunburst High Gloss Finish



## Ibanez AEQ200T Preamp

The Ibanez AEQ200T 2-Band tone control with built-in tuner is optimized for use with Ibanez Under Saddle Pickups. The 7 segment LED display enables you to tune, wherever and whenever necessary.

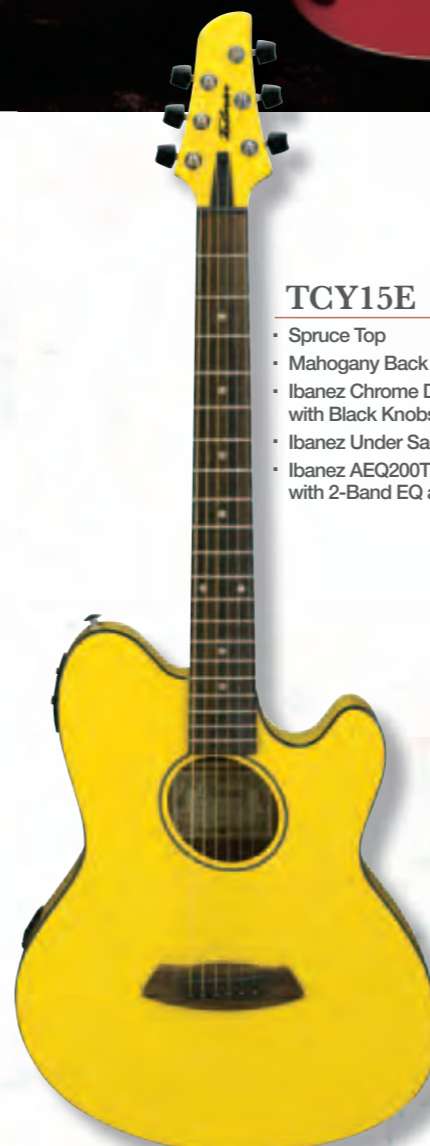

TCY15EYL  
Yellow High Gloss Finish



TCY10EBK  
Black High Gloss Finish



TCY10ETBS  
Transparent Blue Sunburst High Gloss Finish

## TCY20E

- Figured Ash Top
- Figured Ash Back and Sides
- Abalone Rosette
- Ibanez Chrome Die-Cast Tuners
- Ibanez Under Saddle Pickup
- Ibanez AEQ200T Preamp with 2-Band EQ and Onboard Tuner

## TCY15E

- Spruce Top
- Mahogany Back and Sides
- Ibanez Chrome Die-Cast Tuners with Black Knobs
- Ibanez Under Saddle Pickup
- Ibanez AEQ200T Preamp with 2-Band EQ and Onboard Tuner

## TCY10E

- Spruce Top
- Mahogany Back and Sides
- Ibanez Chrome Die-Cast Tuners
- Ibanez Under Saddle Pickup
- Ibanez AEQ200T Preamp with 2-Band EQ and Onboard Tuner

# PF

With PF Performance acoustic and acoustic-electric guitars, you get professional features, quality, and great sound at extremely inexpensive prices backed by the Ibanez name and limited lifetime warranty. The new PF30SNT features a Solid Spruce top and its electric acoustic counter-part, PF30SECE comes equipped with Fishman® Sonicore pickups and Ibanez preamps usually found in more expensive guitars. And the value continues with PC25WC, featuring a beautiful Grand Concert body, and the PF25WC, which boasts a full Dreadnought body and comes with a hard shell case, available in your choice of pure acoustic and acoustic electric models.

## PF Features

- Mahogany Neck
- Mahogany Back and Sides
- Rosewood Bridge and Fretboard
- Ibanez Ivorex II™ Nut and Saddle
- Ibanez Advantage™ Bridge Pins



### Fishman® Sonicore Pickup and Ibanez SST Shape Shifter™ Preamp With Onboard Tuner

PF30SE features a Fishman® Sonicore pickup and Ibanez preamp with balanced XLR and 1/4" outputs for sound and control usually found in more expensive guitars.



### PF30SNT

- Dreadnought Body
- Solid Spruce Top
- Ibanez Chrome Die-Cast Tuners
- Natural High Gloss Finish

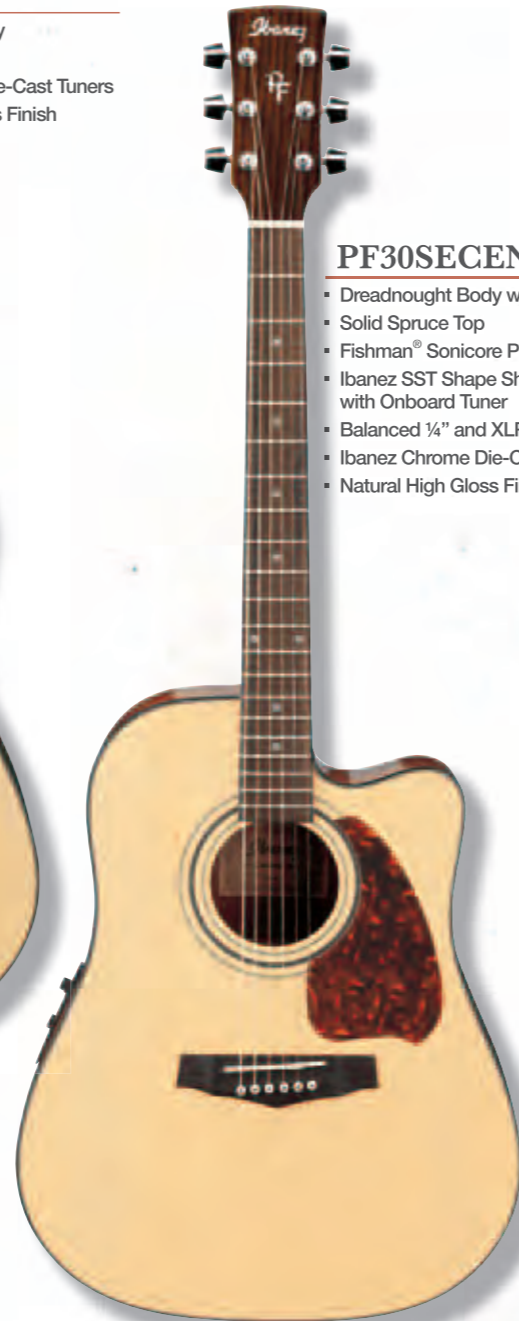

### PF30SECENT

- Dreadnought Body with Cutaway
- Solid Spruce Top
- Fishman® Sonicore Pickup
- Ibanez SST Shape Shifter™ Preamp with Onboard Tuner
- Balanced 1/4" and XLR Outputs
- Ibanez Chrome Die-Cast Tuners
- Natural High Gloss Finish



### PC25ECEWCNT

- Grand Concert Body with Cutaway
- Spruce Top
- Pearloid Rosette
- Ibanez Under Saddle Pickup
- Ibanez AEQ200T Preamp with Onboard Tuner
- Chrome Die-Cast Tuners
- Natural High Gloss Finish
- Hardshell Case Included



### PF25ECEWCLVS

- Dreadnought Body with Cutaway
- Spruce Top
- Pearloid Rosette
- Ibanez Under Saddle Pickup
- Ibanez AEQ200T Preamp with Onboard Tuner
- Chrome Die-Cast Tuners
- Light Violin Sunburst High Gloss Finish
- Hardshell Case Included



### PC25WCNT

- Grand Concert Body
- Spruce Top
- Pearloid Rosette
- Chrome Die-Cast Tuners
- Natural High Gloss Finish
- Hardshell Case Included



### PF25WCNT

- Dreadnought Body
- Spruce Top
- Pearloid Rosette
- Chrome Die-Cast Tuners
- Natural High Gloss Finish
- Hardshell Case Included



### Ibanez AEQ200T Preamp

The Ibanez AEQ200T 2-band tone control with built-in tuner is optimized for use with Ibanez Under Saddle Pickups. The 7 segment LED display enables you to tune, wherever and whenever necessary.



**Hardshell case included with all PF25 and PC25 Models**



**V** You could say that our V Series provides guitars with a brand name at a price you wouldn't expect, but V Series guitars offer a lot more than ultra affordable prices. By getting a guitar with the Ibanez name, you also get the assurance of Ibanez quality, sound and set-up.

### V Features

- Dreadnought Body with Cutaway
- Mahogany Neck
- Mahogany Back and Sides
- Spruce Top
- Chrome Die-Cast Tuners
- Ibanez Under Saddle Pickup
- Ibanez AEQ200 Preamp with 2-Band EQ
- Rosewood Bridge and Fretboard
- Ibanez Ivorex II™ Nut and Saddle
- Ibanez Advantage™ Bridge Pins



**V70CETBS**  
Transparent Blue Sunburst  
High Gloss Finish

**V70CEBK**  
Black High Gloss Finish

**V70CENT**  
Natural High Gloss Finish



**SGE130HS**  
Honey Sunburst High Gloss Finish

**SGE130DVS**  
Dark Violin Sunburst High Gloss Finish

### SGE130

- Jumbo Body
- Spruce Top
- Ibanez AP3 Magnetic Pickup
- Ibanez AEQ200MT Preamp with 2-Band EQ and Onboard Tuner



**SGE130VS**  
Vintage Sunburst High Gloss Finish

# SAGE

There is no rule that your first guitar can't sound and look great. The Sage Series features a selection of body shapes: dreadnought, grand concert and jumbo. Several beautiful sunburst finishes combined with large, classic pickguards contribute to the Sage's understated vintage styling. In appearance, sound, and playability, the Sage Series, including the SGE acoustic/electric models, sets a new benchmark in entry-level guitars.

### SAGE Features

- Mahogany Neck
- Mahogany Back and Sides
- Pearloid Rosette
- Ibanez Chrome Die-Cast Tuners
- Rosewood Bridge and Fretboard
- Ibanez Ivorex II™ Nut and Saddle
- Ibanez Advantage™ Bridge Pins



### AP3 Magnetic Pickup & Ibanez AEQ200MT Preamp

The AP3 magnetic pickup is specially designed to attach to the soundhole of Sage models and produces fat and warm sound, complemented with the AEQ200MT preamp, which has a 2-band tone control and an onboard tuner as well.



### SGT520VS

- Dreadnought Body
- Solid Spruce Top
- Vintage Sunburst High Gloss Finish



### SGT130BK

- Jumbo Body
- Spruce Top
- Black High Gloss Finish



### SGT122NT

- 12-string
- Dreadnought Body
- Spruce Top
- Natural High Gloss Finish



### SGT120NT

- Dreadnought Body
- Spruce Top
- Natural High Gloss Finish



### SGT120TBS

- Dreadnought Body
- Spruce Top
- Transparent Blue Sunburst High Gloss Finish



### SGT120TRS

- Dreadnought Body
- Spruce Top
- Transparent Red Sunburst High Gloss Finish

# SAGE

## SAGE Features

- Mahogany Neck
- Mahogany Back and Sides
- Pearloid Rosette
- Ibanez Chrome Die-Cast Tuners
- Rosewood Bridge and Fretboard
- Ibanez Ivorex II™ Nut and Saddle
- Ibanez Advantage™ Bridge Pins



### SGT120BK

- Dreadnought Body
- Spruce Top
- Black High Gloss Finish



### SGT120LNT

- **Left-Handed**
- Dreadnought Body
- Spruce Top
- Natural High Gloss Finish



### SGT110NT

- Grand Concert Body
- Spruce Top
- Natural High Gloss Finish

# SAGE

## SAGE Features

- Mahogany Neck
- Mahogany Back and Sides
- Pearloid Rosette
- Ibanez Chrome Die-Cast Tuners
- Rosewood Bridge and Fretboard
- Ibanez Ivorex II™ Nut and Saddle
- Ibanez Advantage™ Bridge Pins



### SGT110VS

- Grand Concert Body
- Spruce Top
- Vintage Sunburst High Gloss Finish

## GA Features

- Spruce Top
- Mahogany Neck
- Classical Mosaic Design Rosette
- Ibanez Ivorex II™ Nut and Saddle
- Natural High Gloss Finish

# GA

The Ibanez GA Series classical guitars take the guesswork out of finding an affordable, great-sounding classical guitar that's easy to fret and play. Whether you are looking for a traditional classical-sized instrument or a comfortable nylon-string beginner guitar, the GA models are extremely well-constructed, affordable and have the pristine tonality and playability of much more expensive instruments.



### GA6CE

- Classical Body with Cutaway
- Mahogany Back and Sides
- Gold Classical Tuners
- Rosewood Bridge and Fretboard
- Ibanez Under Saddle Pickup
- Ibanez Preamp with 4-Band EQ



### GA5TCE

- Thinline Classical Body with Cutaway
- Mahogany Back and Sides
- Gold Classical Tuners
- Rosewood Bridge and Fretboard
- Ibanez Under Saddle Pickup
- Ibanez Preamp with 3-Band EQ
- 14th Fret Neck/Body Joint
- Narrow Nut (46mm width vs. Traditional 52 mm Classical width)



### GA5

- Classical Body
- Mahogany Back and Sides
- Chrome Classical Tuners
- Rosewood Bridge and Fretboard



### GA3

- Classical Body
- Catalpa Back and Sides
- Chrome Classical Tuners



# Mandolin

Mandolins have been gracing music since the seventeenth century and their popularity is a testament to their unique, crisp sound. With F-Style and A-Style bodies, we offer six mandolins, from the traditional pure acoustic to the acoustic electric option, all in attractive classic finishes like Brown Sunburst and Dark Violin Sunburst. From Maple necks, Rosewood bridges and fretboards, and your choice of Solid or laminate Spruce tops, there's a mandolin for any melody you want to play.



\*WMC hardshell case sold separately

## Mandolins Features

- Maple Neck
- Rosewood Bridge and Fretboard



### M522SBS

- F-Style Body
- Solid Sitka Spruce Top
- Flamed Maple Back and Sides
- Pearl Block Inlay
- Gold Tuners with Pearloid Knobs
- Brown Sunburst High Gloss Finish



### M511SBS

- A-Style Body
- Solid Spruce Top
- Maple Back and Sides
- Gold Tuners with Pearloid Knobs
- Brown Sunburst High Gloss Finish



### M510EDVS

Dark Violin Sunburst High Gloss Finish



### M510EBS

Brown Sunburst High Gloss Finish



### M510BS

Brown Sunburst High Gloss Finish

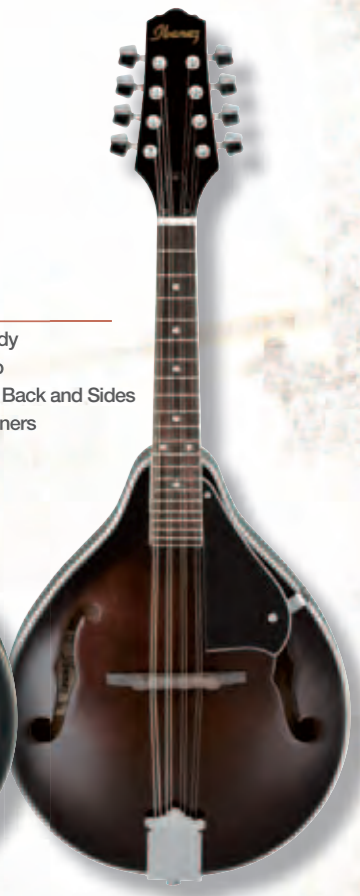

### M510DVS

Dark Violin Sunburst High Gloss Finish

# DT

## DT Features

- Spruce Top
- Mahogany Back and Sides
- Mahogany Neck
- Ibanez Chrome Die-Cast Tuners
- Rosewood Bridge and Fretboard
- Ibanez Ivorex II™ Nut and Saddle
- Ibanez Advantage™ Bridge Pins
- Natural High Gloss Finish

These full-toned mini dreadnoughts are ready to hit the road and don't take up much room. The pure acoustic DT100E features mahogany back and sides and Ibanez onboard tuner. The acoustic-electric DT100ECENT adds an Ibanez EW-style cutaway for easier upper fret access and an Ibanez under saddle pickup and 2-band EQ so you can plug in. Great for both young students and older tour-bus veterans.



### DT100ECENT

- Mini Dreadnought Body with Cutaway
- Ibanez Under Saddle Pickup
- Ibanez AEQ200T Preamp with 2-Band EQ and Onboard Tuner

### DT100ENT

- Mini Dreadnought Body
- Ibanez Onboard Tuner



### Ibanez Onboard Tuner

The DT100E features an onboard tuner for instant tuning.

### Size comparison of DT100ECENT (left) to AW Dreadnought

Size Comparison	Width	Depth	Length	Neck
Dreadnought	15.75"	4.75"	20.0"	25.1"
Mini Dreadnought	12.5"	3.5"	16.0"	22.5"





### Ukulele Features

- Mahogany Neck
- Rosewood Bridge and Fretboard



#### UEW30RWE

- Concert Style EW Body with Cutaway
- Rosewood Body
- Abalone Rosette
- Ibanez Under Saddle Pickup
- Ibanez UK300T Preamp
- Chrome Grover® Open Gear Tuners
- Natural High Gloss Finish
- Padded Gig Bag included



#### UEW20SGE

- Concert Style EW Body with Cutaway
- Spalted Mango Body
- Abalone Rosette
- Ibanez Under Saddle Pickup
- Ibanez UK300T Preamp
- Gold Grover® Open Gear Tuners
- Natural High Gloss Finish
- Padded Gig Bag included



#### UEW20SG

- Concert Style EW Body with Cutaway
- Spalted Mango Body
- Abalone Rosette
- Gold Grover® Open Gear Tuners
- Natural High Gloss Finish
- Padded Gig Bag included



#### UEW10QM

- Concert Style EW Body with Cutaway
- Quilted Maple Body
- Abalone Rosette
- Chrome Grover® Open Gear Tuners
- Natural High Gloss Finish
- Padded Gig Bag included

# Ukulele

The sweet-toned, nylon-stringed ukulele originated in 19th century Hawaii. It gained great popularity in the U.S. during the early 20th century, and from there spread internationally. Ibanez is pleased to offer seven different models, including two with electronics. Our lineup includes soprano and concert-size ukuleles, which bring the rich, textured sounds to your fingertips.



#### Ibanez UK 300T Preamp

The UK-300T Ukulele preamp is equipped with a 2-band EQ for adjusting bass and treble. It also includes a built-in onboard tuner to ensure stable performance every time you hit the stage.



#### UKS50

- Soprano Style Body
- Koa Body
- Abalone Body Binding
- Abalone Rosette
- Gold Grover® Tuners with Black Knobs
- Natural High Gloss Finish
- Padded Gig Bag included



#### UKS10

- Soprano Style Body
- Sapele Body
- Chrome Open Gear Tuners
- Natural Low Gloss Finish
- Gig Bag included



#### UKC10

- Concert Style Body
- Sapele Body
- Chrome Open Gear Tuners
- Natural Low Gloss Finish
- Gig Bag included

# Jam Packs

Jam Packs are perfect for beginning students and come with "Everything You Need To Get Out and Jam" – guitar, electronic tuner, and a whole lot more. Every Jam Pack guitar is individually inspected and features a limited lifetime warranty.



Contents of packages may vary by package model and are subject to change without notice.

## IJAE5BK

Includes: IJAE5BK Acoustic-Electric Guitar, ACA15 Amp, Padded Gig Bag, Guitar Cable, Guitar Strap, Extra Strings, Instructional DVD and Guitar Picks.

## Jam Pack IJAE5BK



## AEG5EBK

- AEG Body
- Basswood Top
- Basswood Back and Sides
- Chrome Die-Cast Tuners
- Rosewood Bridge and Fretboard
- Mahogany Neck
- Ibanez Under Saddle Pickup
- Ibanez AEQ200T Preamp with 2-Band EQ and Onboard Tuner
- Ibanez Ivorex II™ Nut and Saddle
- Ibanez Advantage™ Bridge Pins
- Black Night High Gloss Finish

## Jam Pack Quick Start IJV50



## V50NT

- Dreadnought Body
- Spruce Top
- Agathis Back and Sides
- Chrome Tuners
- Rosewood Bridge and Fretboard
- Mahogany Neck
- Ibanez Ivorex II™ Nut and Saddle
- Ibanez Advantage™ Bridge Pins
- Natural High Gloss Finish



## IV50

Includes: V50NT Guitar, Gig bag, Electronic Tuner, Guitar Strap, Accessories Pouch and Guitar Picks.

## Jam Pack Quick Start IJV30



## V30NT

- 22" scale
- Small Dreadnought Body
- Spruce Top
- Agathis Back and Sides
- Chrome Tuners
- Rosewood Bridge and Fretboard
- Mahogany Neck
- Ibanez Ivorex II™ Nut and Saddle
- Ibanez Advantage™ Bridge Pins
- Natural High Gloss Finish

## Jam Pack IJV100S



## IJV100S

Includes: Black or Natural Solid Top Acoustic Guitar, Gig bag, Guitar Strap, Electronic Tuner, Extra Strings, Accessories Pouch, Instructional DVD and Guitar Picks.



IJV100SBK  
Black High Gloss Finish



IJV100SNT  
Natural High Gloss Finish

## Jam Pack Quick Start IJC30



## IJC 30

Includes: 3/4 Size Classical Guitar, Gig bag, Electronic Tuner and Accessories Pouch.



## IJC30

- 3/4 Classical Body
- Spruce Top
- Catalpa Back and Sides
- Classical Mosaic Design Rosette
- Chrome Classical Tuners
- Mahogany Neck
- Ibanez Ivorex II™ Nut and Saddle
- Natural High Gloss Finish



### T35 Troubadour Control Panel

Troubadour series feature "Mode" switch on T35 and T20 and "Middle Shape" control on T10, both of which make the tonal character change instantly. Troubadour also features onboard chorus with depth and speed control, and MORE!!!

# Amplifiers Troubadour Total Immersion

What's the one thing that almost all small venue musicians strive for when it comes to amplifiers? Some might say "pure immersive tone", which would undoubtedly be followed by "portability". The Ibanez T-Series Acoustic Guitar Amplifiers deliver exactly that, along with the striking appearance of a hand-crafted boutique amplifier. Whether you're strumming away at the local coffee shop or playing weekly gigs at a religious venue, the sounds of the T-Series will fill the room. Plus, you won't have to break your back getting your amp in and out. The Ibanez T-Series was designed with portability in mind.

### T10 Troubadour

**output power** 10w  
**speaker unit** 6.5" Speaker  
**cabinet** Closed Cabinet, Tilt-up System  
**controls** Mid Shape Control  
Hue Control  
Chorus w/Speed Control  
Internal Limiter  
**i/o's** Guitar Input, CD/AUX Input  
Headphones/Line Out  
**size** 205(W) x 258(H) x 195(D) (mm)  
**weight** 3.4kg

### T20 Troubadour

**output power** 20w  
**speaker unit** 8" Coaxial Speaker (with tweeter)  
**cabinet** Sealed Back Cabinet, Tilt-up System  
**controls** 3 Band Eq w/Sweepable Mid  
Natural Mode/Shaped Mode  
Chorus w/Depth & Speed Control, Reverb  
Mic Channel w/Tone Control, Internal Limiter  
**i/o's** Guitar Input, Microphone Input (XLR)  
CD/AUX Input, Headphones/Line Out  
**size** 267(W) x 318(H) x 241(D) (mm)  
**weight** 6.6kg

### T35 Troubadour

**output power** 35w  
**speaker unit** 10" Coaxial Speaker (with tweeter)  
**cabinet** Ported Bass Reflection Cabinet, Tilt-up System  
**controls** 3 Band Eq w/Sweepable Mid  
Natural Mode/Shaped Mode  
Chorus w/Depth & Speed Control, Reverb  
Mic Channel w/Tone Control, Internal Limiter  
Guitar Input, Microphone Input (XLR)  
**i/o's** CD/AUX Input, Headphones Out, Stereo Balanced  
Line Out/Foot Switch Jack (Chorus/Reverb)  
**size** 325(W) x 396(H) x 304(D) (mm)  
**weight** 10.5kg

### T80 Troubadour

**output power** 80W  
**speaker unit** 2 x 8" Ibanez custom speaker w/Piezo tweeter  
**cabinet** Closed-back cabinet w/Tilt-up System  
**controls** Notch Filter, Phase Invert, Mute, Master Volume, Aux Volume  
Instrument CH.: Volume, Treble, Middle, Bass, Chorus, Reverb  
Mic. CH.: Line/Mic. Select, Phantom Power Select,  
Volume, Treble, Middle, Bass, Chorus, Reverb  
Phones Out, Aux In, Line Out (Stereo), Footswitch (Chorus,  
Reverb, Notch Filter, Phase, Mute)  
**i/o's** 360(W) x 340(D) x 475(H) (mm)  
**size** 325(W) x 396(H) x 304(D) (mm)  
**weight** 13.4kg

# Cases

## Genuine Ibanez Cases

Only genuine Ibanez cases and bags are designed specifically to fit and protect your Ibanez acoustic guitar.



### HARDSHELL FITTING

CASE	MODELS
AC100C	AC, AES, EWC, SGT110, MONTAGE
AEB50C	AEB
AEG10C	AEG, EWN, GA5TCE
AEL50C	AEL, EW
EWB50C	EWB
GA50C	GA (except GA5TCE)
JB50C	SGT130, SGE
PF50C	All Dreadnoughts, AEF
TM50C	Talman
WMC	A Style Mandolin
WMFC	F Style Mandolin

### GIG BAG FITTING

BAG	MODELS
ISAB501BK	Dreadnought
ISAJB501BK	Jumbo
ISCB501BK	Classical
ISABB501BK	Acoustic Bass



# Mic Stands

For mic-ing vocals, guitars and amps, these stands from TAMA, the Strongest Name in Drums, offer fast set up, stability, and roadworthy durability.

**MS200**  
Straight Stand

**MS205**  
Boom Stand

**MS200D**  
Straight Stand

**MS205ST**  
Short Boom Stand

### ISAB501, ISCB501, ISAJB501, ISABB501

• Affordable gig bag with standard padding for Ibanez guitars

**70WG**  
• Gig bag for dreadnought guitars

### ABP Gig Bag with BACKPACK

- Deluxe gig bag for Ibanez dreadnought acoustics
- Water-resistant exterior
- Super-thick, soft-padded interior
- Removable back pack



## Dimensions:

Neck Model	Scale Length	Fretboard Radius	Thickness at 1st Fret	Thickness at 7th Fret	Width at Nut	Width at Body Joint
AC	634mm	300mm	22mm	24mm	44.5mm	57mm
AEB	812.8mm	300mm	23.5mm	25.5mm	43.5mm	58mm
AEF	641mm	300mm	20mm	21mm	43mm	55mm
AEG	648mm	300mm	20mm	21mm	43mm	55mm
AEG10NE	650mm	FLAT	21.5mm	22.5mm	46mm	58mm
AEL	650mm	340mm	21mm	23mm	43mm	55mm
AEL2012	650mm	340mm	21mm	23mm	48mm	60mm
AW	648mm	300mm	22mm	24mm	43mm	55mm
DT	571mm	300mm	20mm	21mm	43mm	54mm
EP	643mm	300mm	20mm	21mm	43mm	55mm
EW/EWC	641mm	300mm	20mm	21mm	43mm	55mm
EW2012E	641mm	300mm	21mm	22mm	48mm	60mm
EWB	863.6mm	340mm	21mm	22.5mm	43.5mm	58mm
EWB205	863.6mm	340mm	21mm	22.5mm	47mm	63.5mm
EWN	641mm	FLAT	21mm	22mm	46mm	58mm
GA	650mm	FLAT	22mm	24mm	52mm	63.5mm
GA5TCE	650mm	FLAT	21mm	22.5mm	46mm	58mm
IJAE5BK	648mm	300mm	20mm	21mm	43mm	55mm
IJC30	590mm	FLAT	21mm	23mm	46mm	60mm
IJV100S	648mm	300mm	20mm	21mm	43mm	55mm
IJV50	648mm	300mm	20mm	21mm	43mm	55mm
IJV30	560mm	300mm	20mm	21mm	43mm	54mm
JSA	641mm	300mm	20mm	21mm	43mm	55.4mm
MANDOLIN (F-STYLE)	350mm	FLAT	22.5mm	24.5mm	30mm	40mm
MANDOLIN (A-STYLE)	350mm	FLAT	22mm	24.5mm	30mm	40mm
MONTAGE	641mm	300mm	20mm	21mm	43mm	55mm
PF/PC	648mm	300mm	20mm	21mm	43mm	55mm
SGT/SGE	648mm	300mm	20mm	21mm	43mm	55mm
SGT122	648mm	300mm	21mm	23mm	48mm	59mm
TCY	648mm	300mm	20mm	21mm	43mm	55mm
TCM	641mm	300mm	20mm	21mm	43mm	55.4mm
UEW	382mm	FLAT	17.6mm	20.6mm	35mm	44mm
UKC10	382mm	FLAT	17.6mm	20.6mm	35mm	44mm
UKS10	350mm	FLAT	17.6mm	20.6mm	35mm	44mm
UKS50	345mm	FLAT	17.6mm	20.6mm	35mm	44mm
V70CE	650mm	300mm	20mm	21mm	43mm	55mm

## Neck

Body Width, Depth and Length

## Body

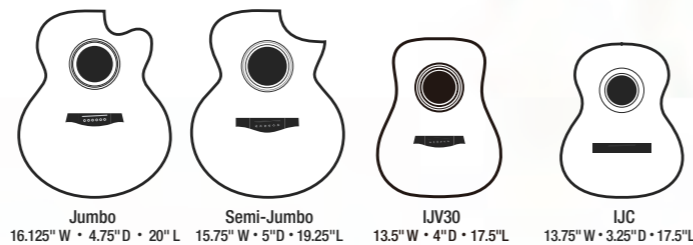
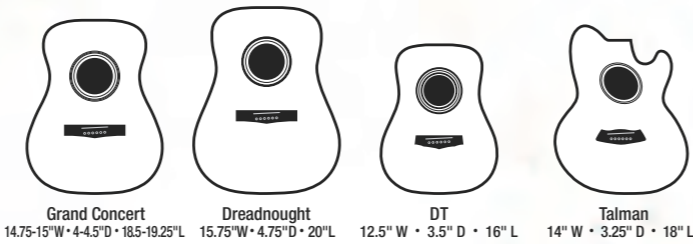
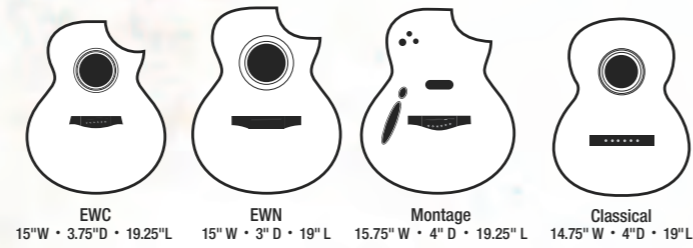
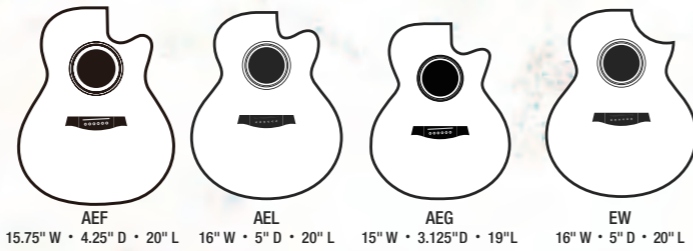

### ADVANTAGE™ BRIDGE PINS

These pins really are an advantage over old-fashioned pins. Advantage™ pins are easier to take out and easier to put in than standard pins. A special bulb-shaped end makes the pin easy to grip and also prevents the pin from being pushed in too far. Best of all, with Advantage™, the pin and string stay put.

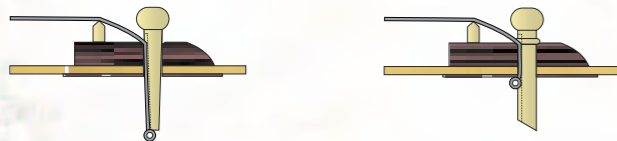

### STANDARD PINS

With standard pins, the ball can become caught up on the end of the pin, which can result in string slippage during tuning.

### ADVANTAGE™ PINS

Advantage™ bridge pins hold the string ball where it should be—right under the top for better sound, stability and security.



### BALANCED 1/4" & XLR OUTPUTS

Many Ibanez acoustic guitars feature both 1/4" and XLR outputs for increased versatility.



### IVOREX II™ NUT & SADDLE

Ivorex II™ nuts are stronger and more durable than bone and even harder than the original Ivorex. Ivorex II allows brilliant highs and more pronounced lows with less mid-range which makes Ivorex II-fitted guitars perfect for amplification.

Visit [ibanez.com](http://ibanez.com) for complete technical specs, special features and up-to-the-minute updates.



# Ibanez Artists



Ibanez is proud to feature D'Addario® EXP™ strings on many acoustic guitars and basses. EXP™ strings retain brightness three to four times longer than the same uncoated string, while retaining a great natural feel.



The Ibanez logo is rendered in a white, stylized script font, enclosed within a white oval border. The background of the entire page is a dark, high-contrast image of a bird's wing, with the feathers appearing as intricate, layered patterns of light and dark tones.

All colors shown are as close as four-color  
printing will allow.  
All specifications are subject to change  
without notice.

©2010 Printed in Japan OCT10813

### Special Thanks to:

#### Musicians:

Jaryd Tookmanian  
Noah Young  
The Mechanicals  
[www.myspace.com/themechanicalsmusic](http://www.myspace.com/themechanicalsmusic)  
[themechanicals.bandcamp.com](http://themechanicals.bandcamp.com)

Jady Young  
Convict Gypsy  
[www.myspace.com/convictgypsy](http://www.myspace.com/convictgypsy)

John Paul Selwyn  
Twilight Music  
[www.myspace.com/johnselwyn](http://www.myspace.com/johnselwyn)

Chris Johnson  
[www.myspace.com/lostincompany](http://www.myspace.com/lostincompany)

Chris Kasper  
[www.ChrisKasper.com](http://www.ChrisKasper.com)

Davitt Terrell  
Buoyant Sea  
[www.myspace.com/buoyantsea](http://www.myspace.com/buoyantsea)

#### Locations:

Cedar Street Studios  
[www.cedarstreetstudios.com](http://www.cedarstreetstudios.com)