

NEWTON SOLAR OVEN 2: AXONOMETRY VIEW

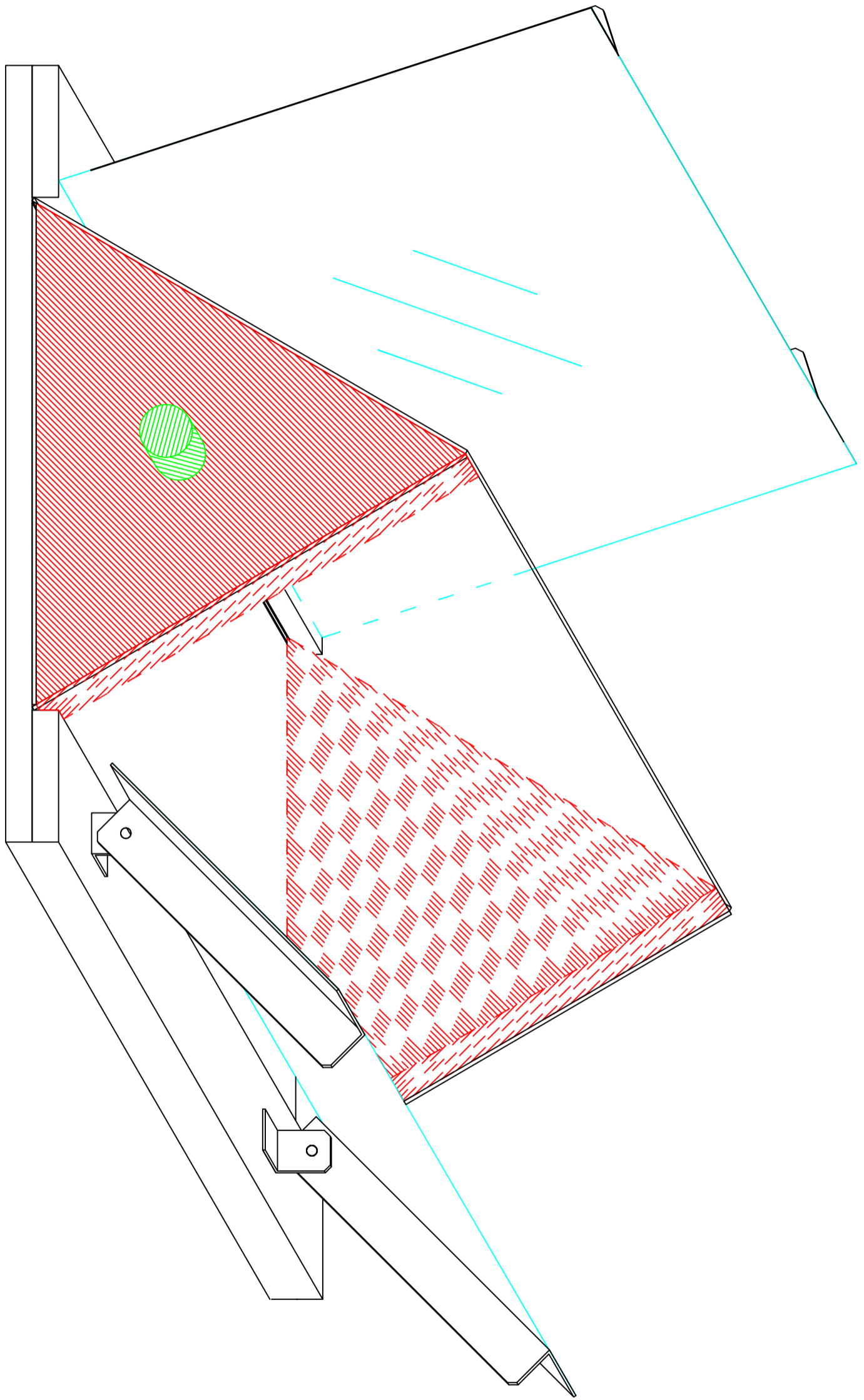

NEWTON SOLAR OVEN 2
COPYRIGHT BY MATTEO MUCCIOLI, RIMINI, ITALY, 09/08/2019
FOR INFORMATION CONTACT AT matteo.muccioli@gmail.com or FACEBOOK PAGE "STUDIO MUMALAB" or "MATTEO MUCCIOLI"
SOLAR BOX MADE ENTIRELY IN GLASS, PAY IMPORTANT ATTENTION: USERS ASSUMES ALL RISKS.
USE ALL SAFETY SYSTEMS TO PROTECT THE EYES AND THE REST OF THE BODY. DO NOT OPERATE IN WIND CONDITIONS.
DO NOT LEAVE UNSUPERVISED. WEAR SUNGLASSES OR DARKER EYE PROTECTION
I AM NOT RESPONSIBLE FOR AN IMPROPER USE

NEWTON SOLAR OVEN 2: GLASS SIZE

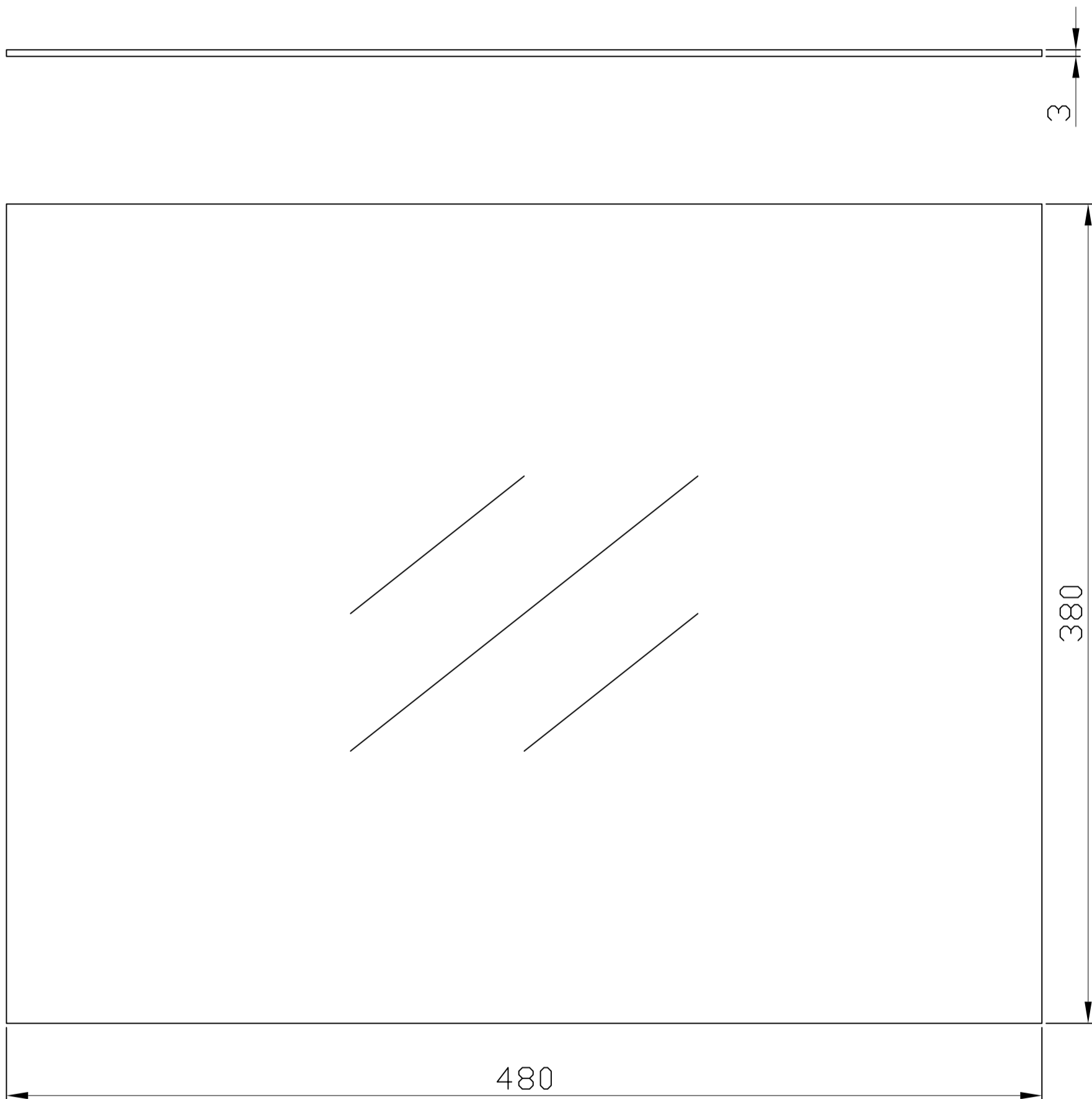

NEWTON SOLAR OVEN 2

COPYRIGHT BY MATTEO MUCCIOLI, RIMINI, ITALY, 09/08/2019

FOR INFORMATIONS CONTACT AT matteo.muccioli@gmail.com or FACEBOOK PAGE "STUDIO MUMALAB" or "MATTEO MUCCIOLI"

SOLAR BOX MADE ENTIRELY IN GLASS, PAY IMPORTANT ATTENTION: USERS ASSUMES ALL RISKS.

USE ALL SAFETY SYSTEMS TO PROTECT THE EYES AND THE REST OF THE BODY. DO NOT OPERATE IN WIND CONDITIONS.

DO NOT LEAVE UNSUPERVISED. WEAR SUNGLASSES OR DARKER EYE PROTECTION

I AM NOT RESPONSIBLE FOR AN IMPROPER USE

NEWTON SOLAR OVEN 2: PLAN VIEW

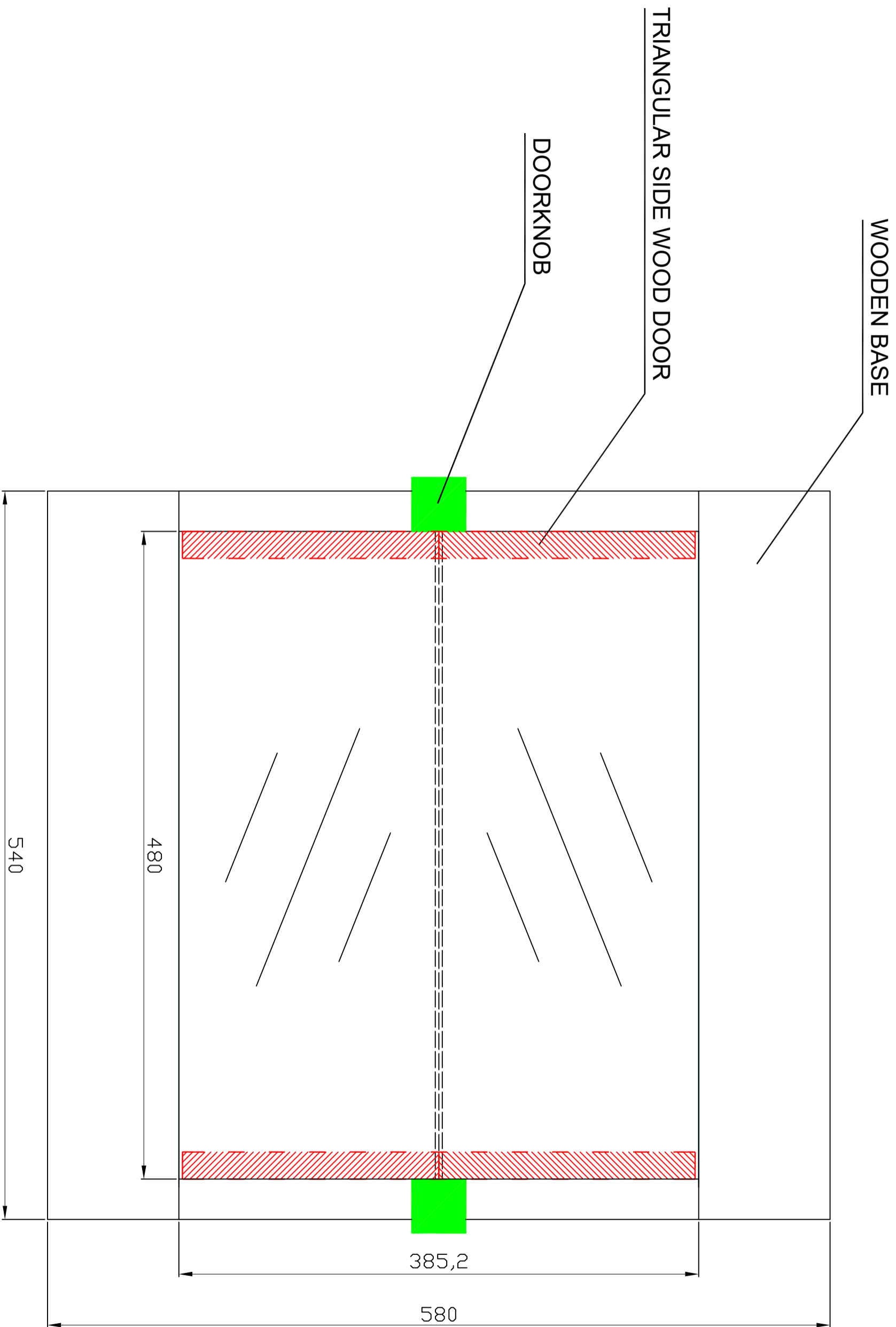

NEWTON SOLAR OVEN 2

COPYRIGHT BY MATTEO MUCCIOLI, RIMINI, ITALY, 09/08/2019

FOR INFORMATION CONTACT AT matteo.muccioli@gmail.com or FACEBOOK PAGE "STUDIO MUMALAB" or "MATTEO MUCCIOLI"

SOLAR BOX MADE ENTIRELY IN GLASS, PAY IMPORTANT ATTENTION: USERS ASSUMES ALL RISKS.

USE ALL SAFETY SYSTEMS TO PROTECT THE EYES AND THE REST OF THE BODY. DO NOT OPERATE IN WIND CONDITIONS.

DO NOT LEAVE UNSUPERVISED. WEAR SUNGLASSES OR DARKER EYE PROTECTION

I AM NOT RESPONSIBLE FOR AN IMPROPER USE

NEWTON SOLAR OVEN 2: OPEN GLASSES

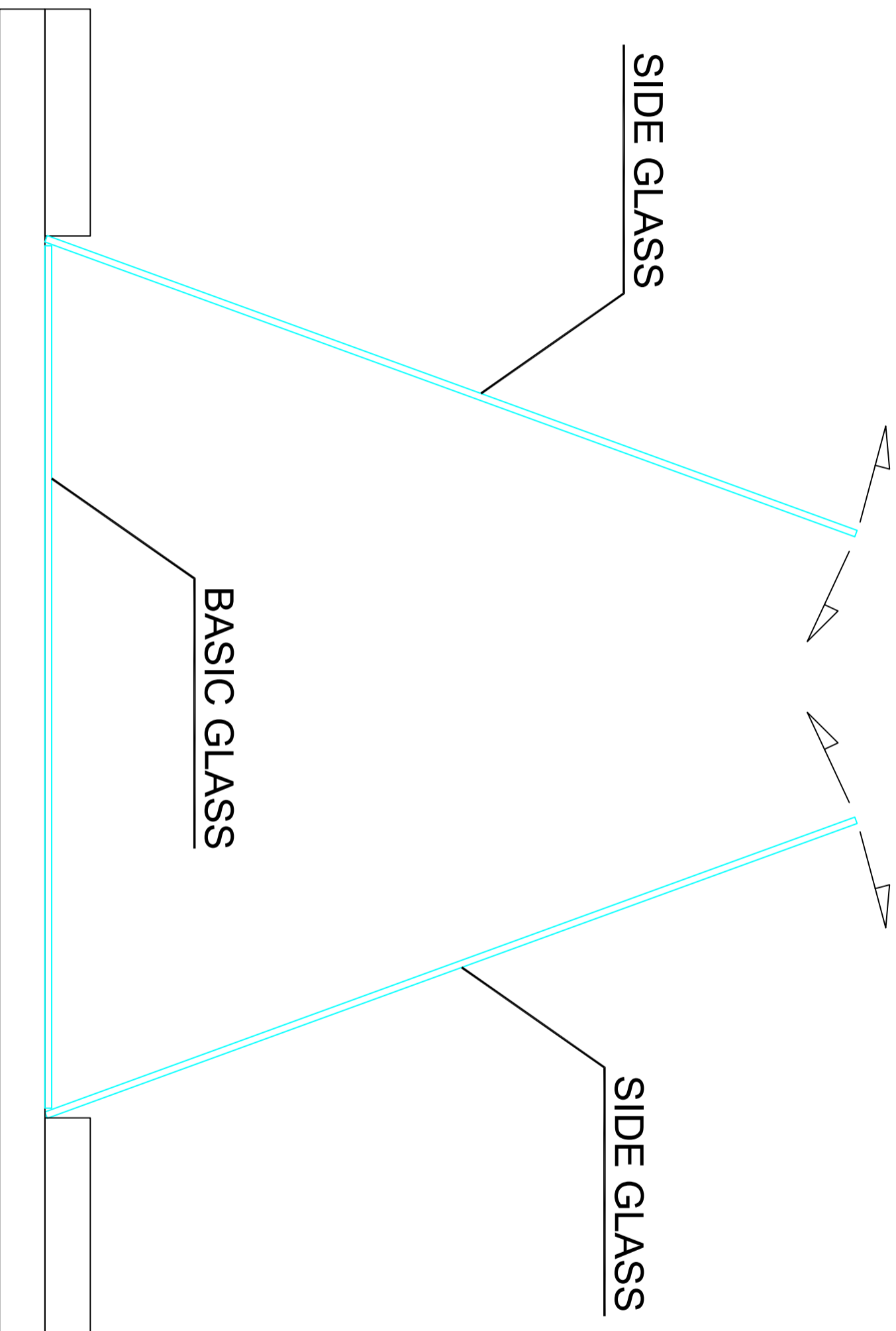

NEWTON SOLAR OVEN 2

COPYRIGHT BY MATTEO MUCCIOLI, RIMINI, ITALY, 09/08/2019

FOR INFORMATIONS CONTACT AT matteo.muccioli@gmail.com or FACEBOOK PAGE "STUDIO MUMALAB" or "MATTEO MUCCIOLI"
SOLAR BOX MADE ENTIRELY IN GLASS, PAY IMPORTANT ATTENTION: USERS ASSUMES ALL RISKS.

USE ALL SAFETY SYSTEMS TO PROTECT THE EYES AND THE REST OF THE BODY. DO NOT OPERATE IN WIND CONDITIONS.

DO NOT LEAVE UNSUPERVISED. WEAR SUNGLASSES OR DARKER EYE PROTECTION

I AM NOT RESPONSIBLE FOR AN IMPROPER USE

NEWTON SOLAR OVEN 2: OPEN GLASSES

SELF-SUPPORTING STRUCTURE

SIDE DOORS ARE BOX CLOSING AND GLASSES SUPPORTS

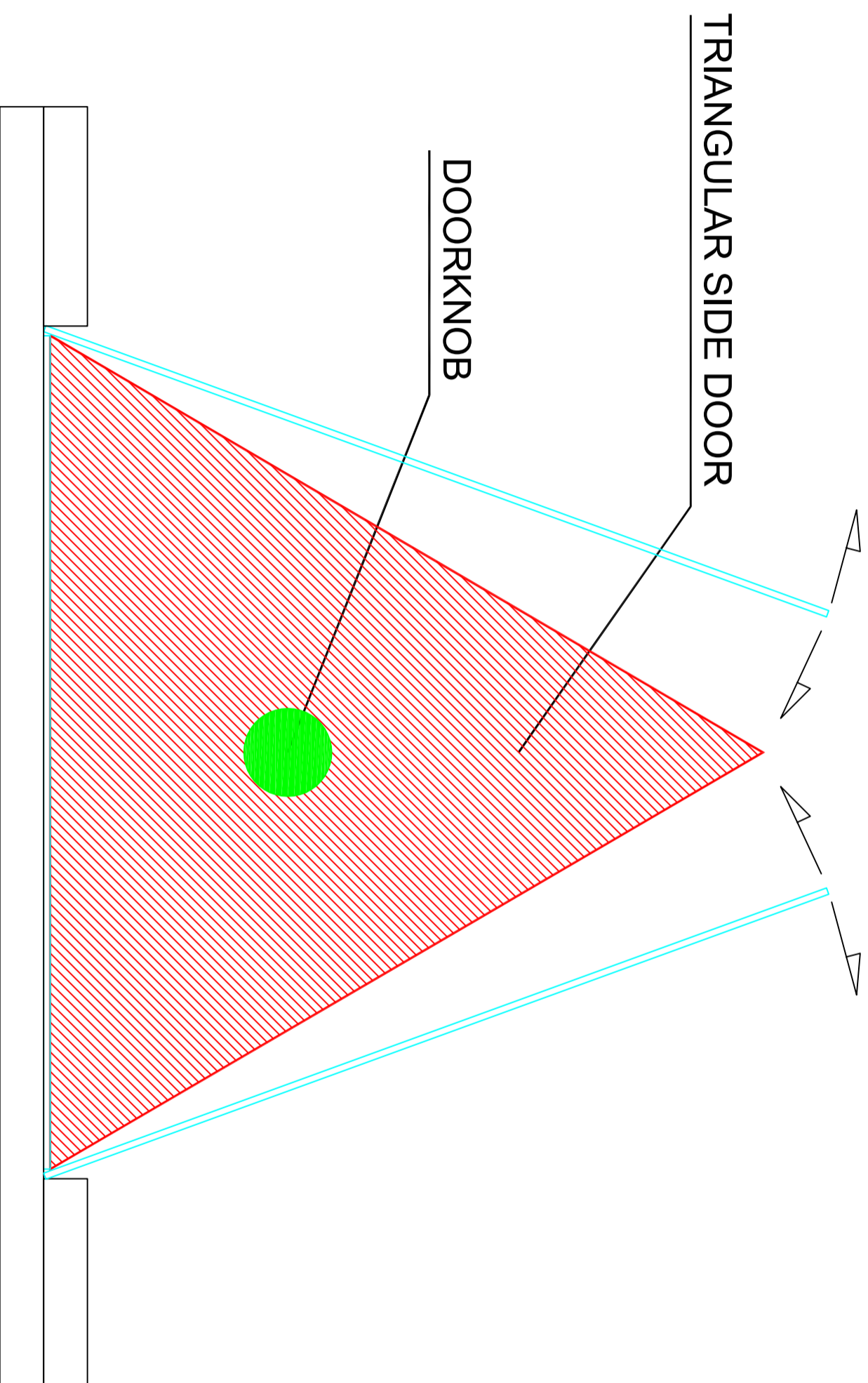

NEWTON SOLAR OVEN 2

COPYRIGHT BY MATTEO MUCCIOLI, RIMINI, ITALY, 09/08/2019

FOR INFORMATION CONTACT AT matteo.muccioli@gmail.com or FACEBOOK PAGE "STUDIO MUMALAB" or "MATTEO MUCCIOLI"

SOLAR BOX MADE ENTIRELY IN GLASS, PAY IMPORTANT ATTENTION: USERS ASSUMES ALL RISKS.

USE ALL SAFETY SYSTEMS TO PROTECT THE EYES AND THE REST OF THE BODY. DO NOT OPERATE IN WIND CONDITIONS.

DO NOT LEAVE UNSUPERVISED. WEAR SUNGLASSES OR DARKER EYE PROTECTION

I AM NOT RESPONSIBLE FOR AN IMPROPER USE

NEWTON SOLAR OVEN 2: SIDE VIEW

SELF-SUPPORTING STRUCTURE

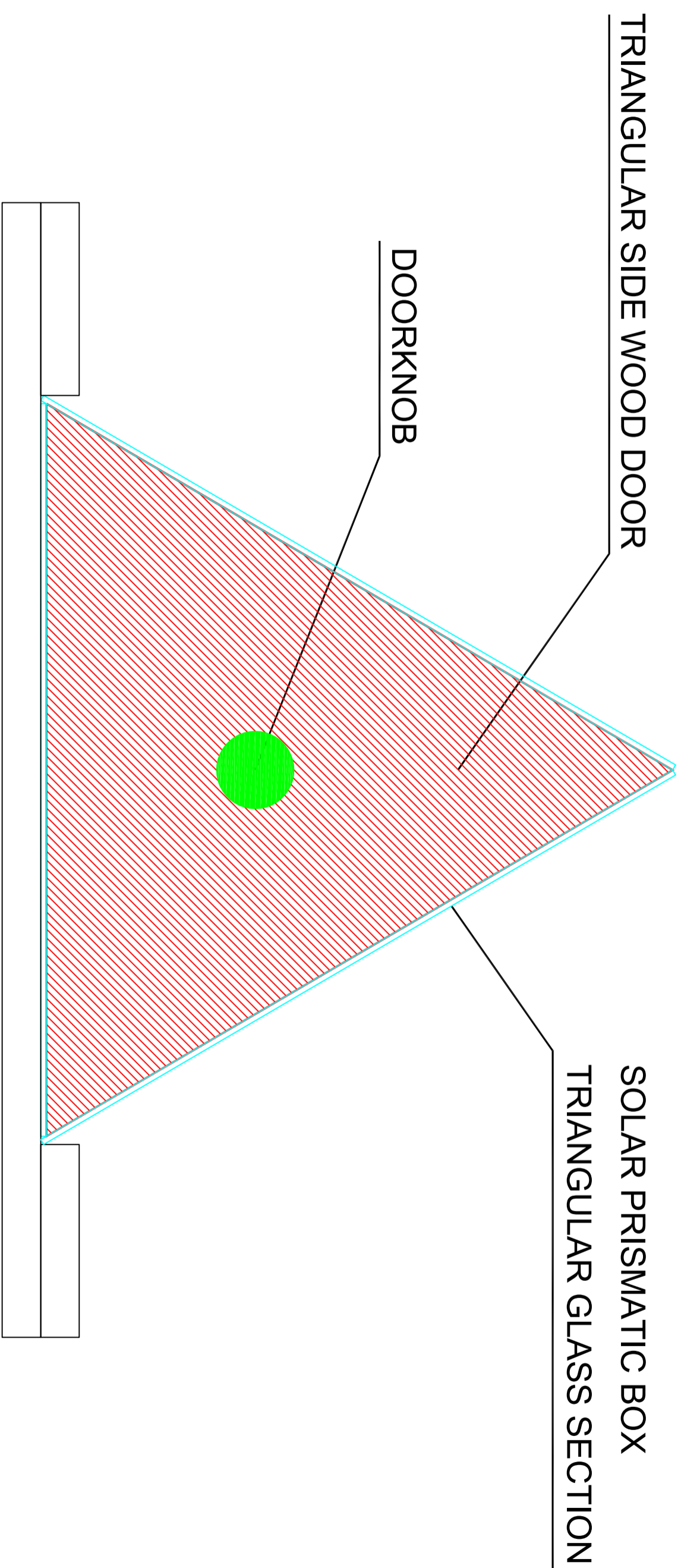

NEWTON SOLAR OVEN 2
COPYRIGHT BY MATTEO MUCCIOLI, RIMINI, ITALY, 09/08/2019
FOR INFORMATIONS CONTACT AT matteo.muccioli@gmail.com or FACEBOOK PAGE "STUDIO MUMALAB" or "MATTEO MUCCIOLI"
SOLAR BOX MADE ENTIRELY IN GLASS, PAY IMPORTANT ATTENTION: USERS ASSUMES ALL RISKS.
USE ALL SAFETY SYSTEMS TO PROTECT THE EYES AND THE REST OF THE BODY. DO NOT OPERATE IN WIND CONDITIONS.
DO NOT LEAVE UNSUPERVISED. WEAR SUNGLASSES OR DARKER EYE PROTECTION
I AM NOT RESPONSIBLE FOR AN IMPROPER USE

NEWTON SOLAR OVEN 2: SIDE VIEW

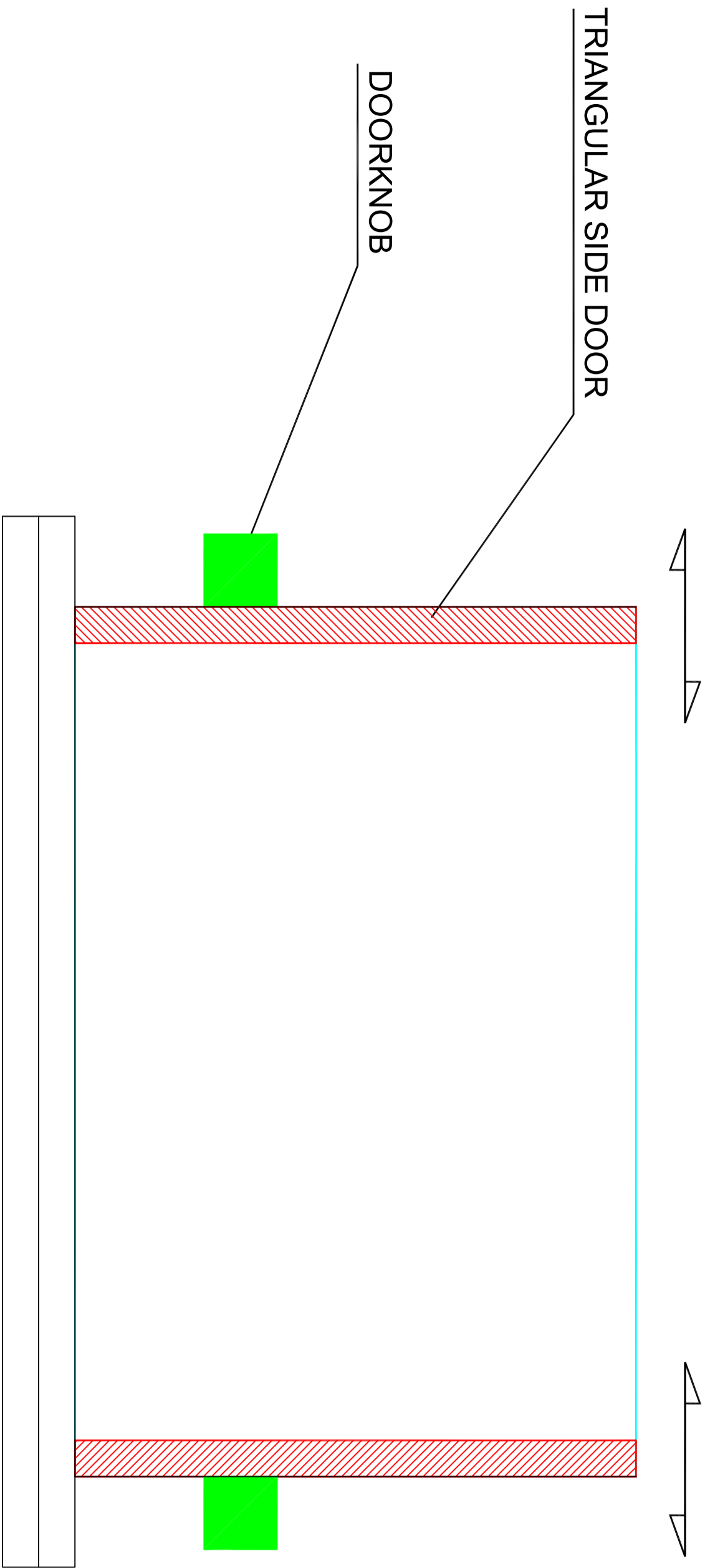

NEWTON SOLAR OVEN 2
COPYRIGHT BY MATTEO MUCCIOLI, RIMINI, ITALY, 09/08/2019
FOR INFORMATION CONTACT AT matteo.muccioli@gmail.com or FACEBOOK PAGE "STUDIO MUMALAB" or "MATTEO MUCCIOLI"
SOLAR BOX MADE ENTIRELY IN GLASS. PAY IMPORTANT ATTENTION: USERS ASSUMES ALL RISKS.
USE ALL SAFETY SYSTEMS TO PROTECT THE EYES AND THE REST OF THE BODY. DO NOT OPERATE IN WIND CONDITIONS.
DO NOT LEAVE UNSUPERVISED. WEAR SUNGLASSES OR DARKER EYE PROTECTION
I AM NOT RESPONSIBLE FOR AN IMPROPER USE

POSSIBILITY OF REDUCING THE INTERNAL VOLUME BY MOVING THE DOORS

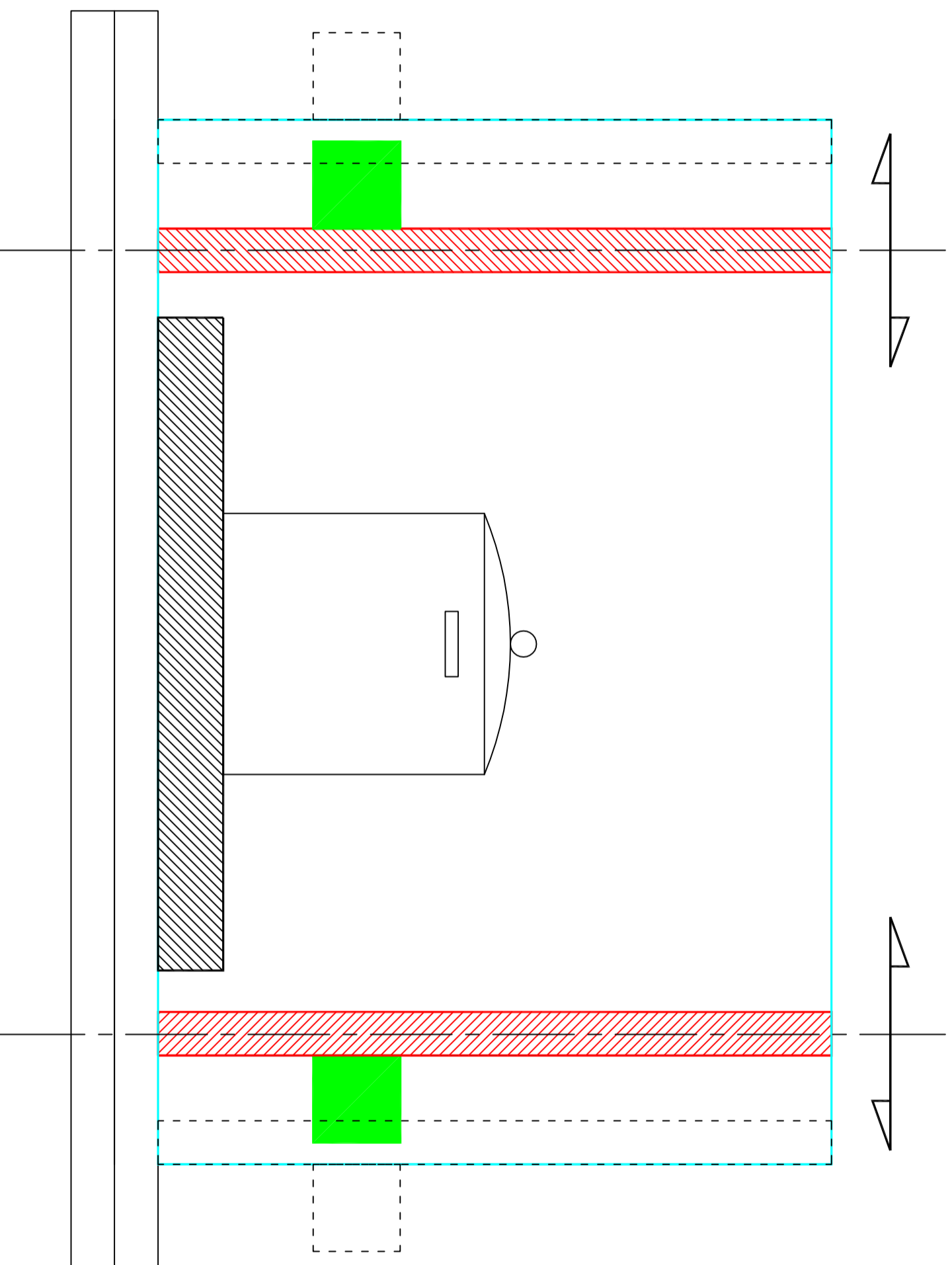

NEWTON SOLAR OVEN 2

COPYRIGHT BY MATTEO MUCCIOLI, RIMINI, ITALY, 09/08/2019

FOR INFORMATION CONTACT AT matteo.muccioli@gmail.com or FACEBOOK PAGE "STUDIO MUMALAB" or "MATTEO MUCCIOLI"
SOLAR BOX MADE ENTIRELY IN GLASS, PAY IMPORTANT ATTENTION: USERS ASSUMES ALL RISKS.

USE ALL SAFETY SYSTEMS TO PROTECT THE EYES AND THE REST OF THE BODY. DO NOT OPERATE IN WIND CONDITIONS.

DO NOT LEAVE UNSUPERVISED. WEAR SUNGLASSES OR DARKER EYE PROTECTION

I AM NOT RESPONSIBLE FOR AN IMPROPER USE

NEWTON SOLAR OVEN: BASE MIRROR SIZE

REAR PRIMARY MIRROR

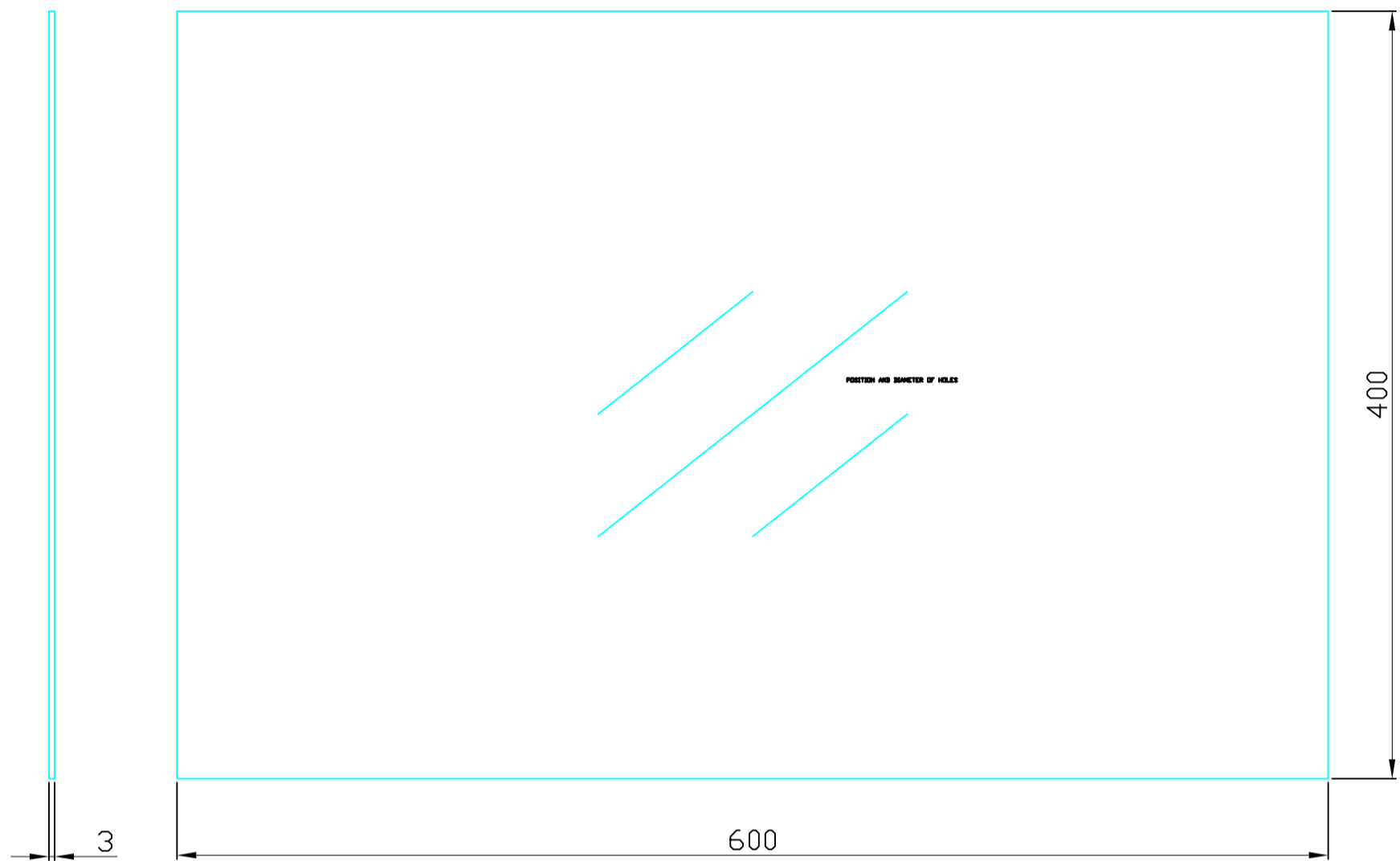

FRONT SECONDARY MIRROR

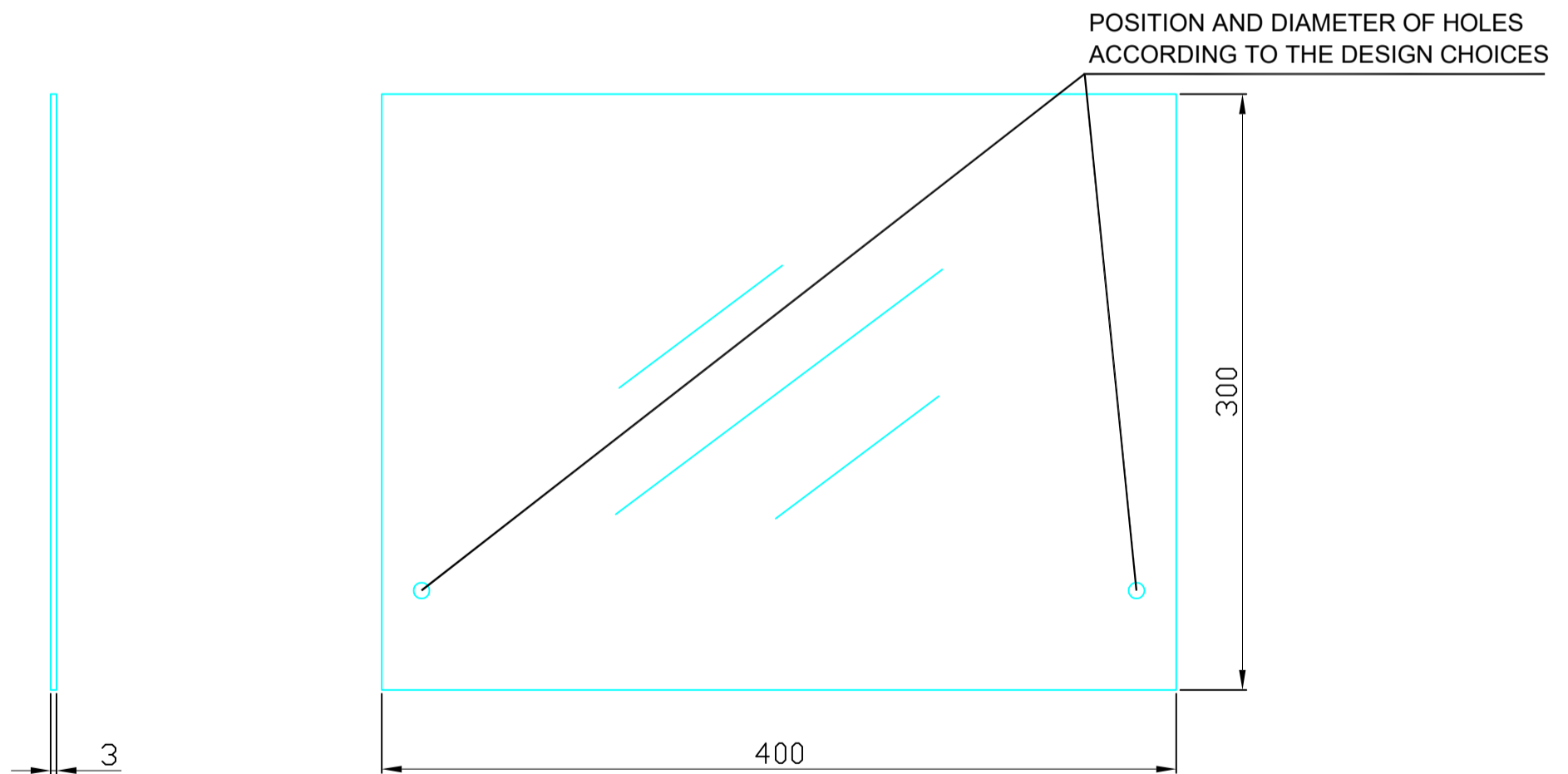

NEWTON SOLAR OVEN: BASE MIRROR ASSEMBLY

SIDE VIEW

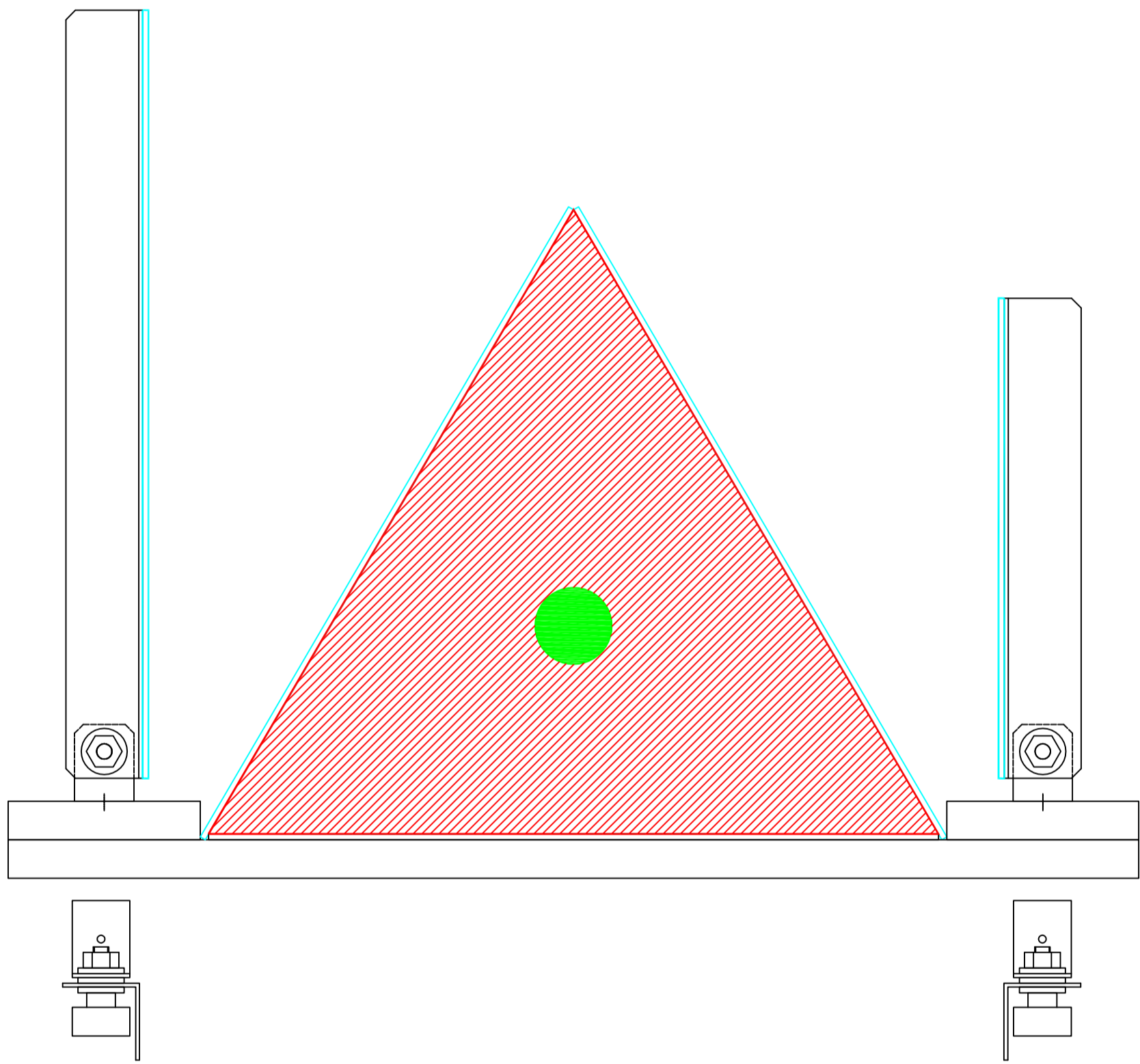

NEWTON SOLAR OVEN 2
COPYRIGHT BY MATTEO MUCCIOLI, RIMINI, ITALY, 09/08/2019
FOR INFORMATIONS CONTACT AT matteo.muccioli@gmail.com or FACEBOOK PAGE "STUDIO MUMALAB" or "MATTEO MUCCIOLI"
SOLAR BOX MADE ENTIRELY IN GLASS, PAY IMPORTANT ATTENTION: USERS ASSUMES ALL RISKS.
USE ALL SAFETY SYSTEMS TO PROTECT THE EYES AND THE REST OF THE BODY. DO NOT OPERATE IN WIND CONDITIONS.
DO NOT LEAVE UNSUPERVISED. WEAR SUNGLASSES OR DARKER EYE PROTECTION
I AM NOT RESPONSIBLE FOR AN IMPROPER USE

NEWTON SOLAR OVEN: BASE MIRROR ASSEMBLY

PLAN VIEW

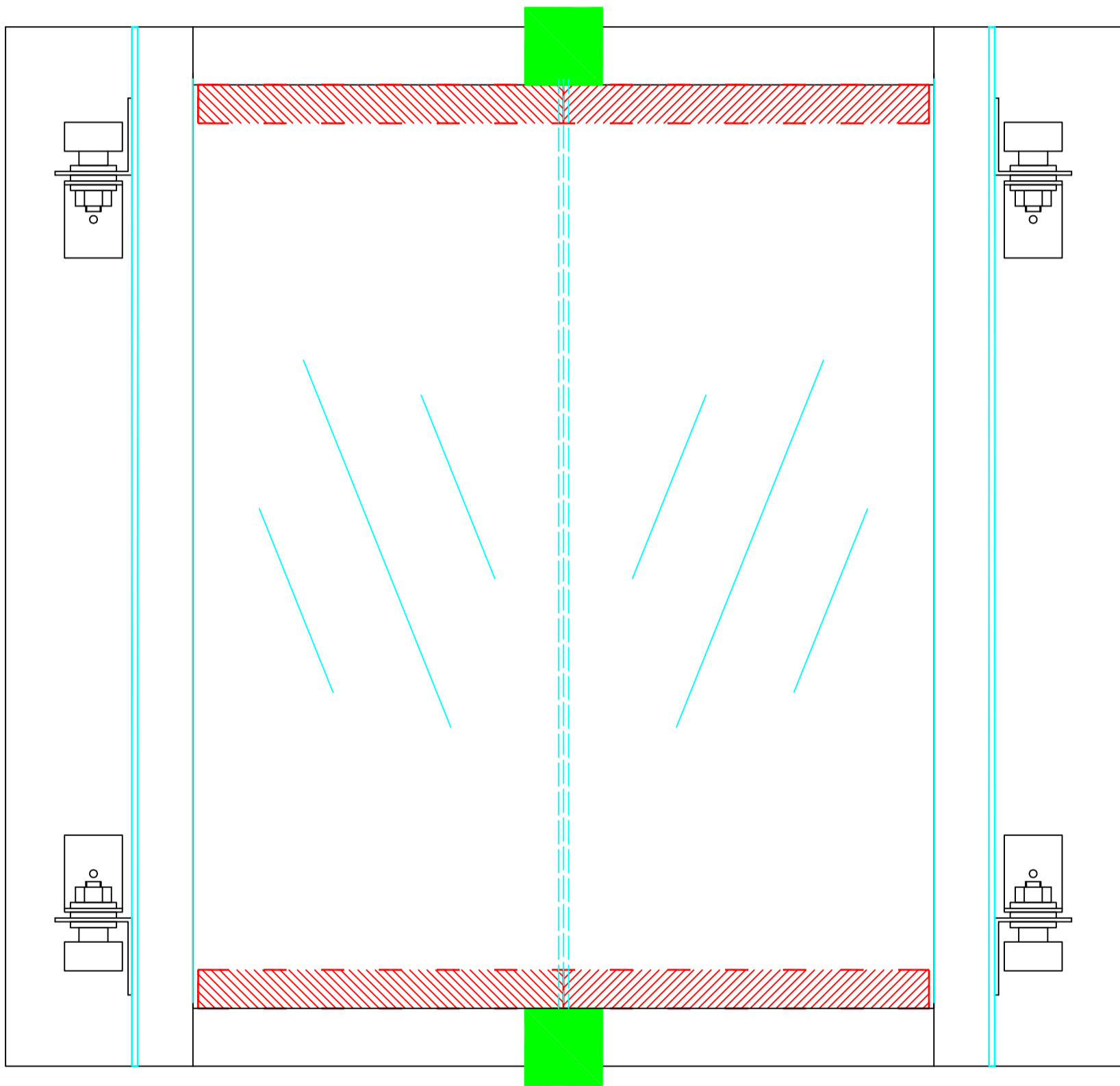

NEWTON SOLAR OVEN 2

COPYRIGHT BY MATTEO MUCCIOLI, RIMINI, ITALY, 09/08/2019

FOR INFORMATIONS CONTACT AT matteo.muccioli@gmail.com or FACEBOOK PAGE "STUDIO MUMALAB" or "MATTEO MUCCIOLI"

SOLAR BOX MADE ENTIRELY IN GLASS, PAY IMPORTANT ATTENTION: USERS ASSUMES ALL RISKS.

USE ALL SAFETY SYSTEMS TO PROTECT THE EYES AND THE REST OF THE BODY. DO NOT OPERATE IN WIND CONDITIONS.

DO NOT LEAVE UNSUPERVISED. WEAR SUNGLASSES OR DARKER EYE PROTECTION

I AM NOT RESPONSIBLE FOR AN IMPROPER USE

NEWTON SOLAR OVEN 2: BASE MIRROR ASSEMBLY

AXONOMETRY VIEW: MIRRORS SUPPORTS

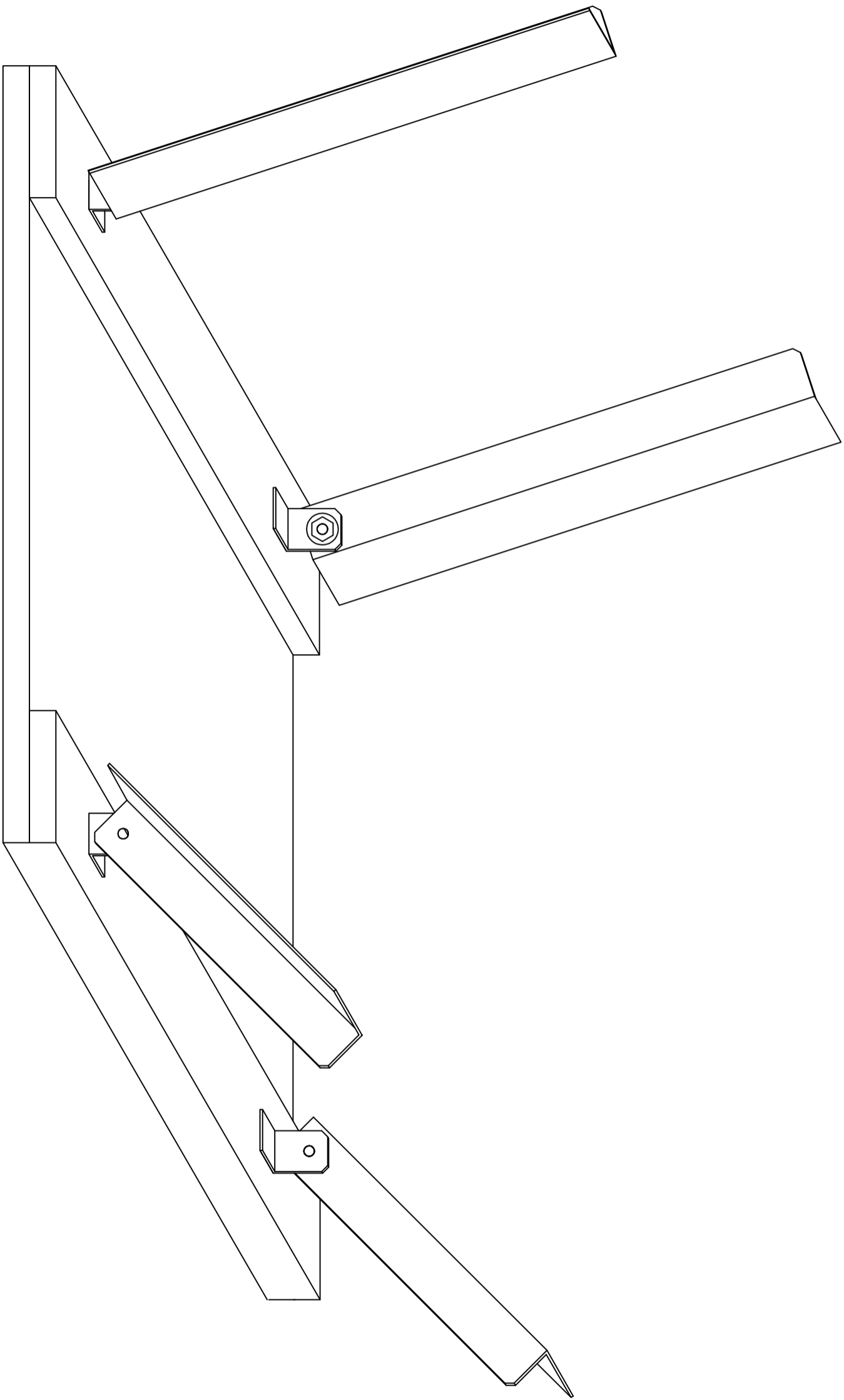

NEWTON SOLAR OVEN 2

COPYRIGHT BY MATTEO MUCCIOLI, RIMINI, ITALY, 09/08/2019

FOR INFORMATION CONTACT AT matteo.muccioli@gmail.com or FACEBOOK PAGE "STUDIO MUMALAB" or "MATTEO MUCCIOLI"

SOLAR BOX MADE ENTIRELY IN GLASS, PAY IMPORTANT ATTENTION: USERS ASSUMES ALL RISKS.

USE ALL SAFETY SYSTEMS TO PROTECT THE EYES AND THE REST OF THE BODY. DO NOT OPERATE IN WIND CONDITIONS.

DO NOT LEAVE UNSUPERVISED. WEAR SUNGLASSES OR DARKER EYE PROTECTION

I AM NOT RESPONSIBLE FOR AN IMPROPER USE

NEWTON SOLAR OVEN 2: BASE MIRROR ASSEMBLY

AXONOMETRY VIEW: MIRRORS

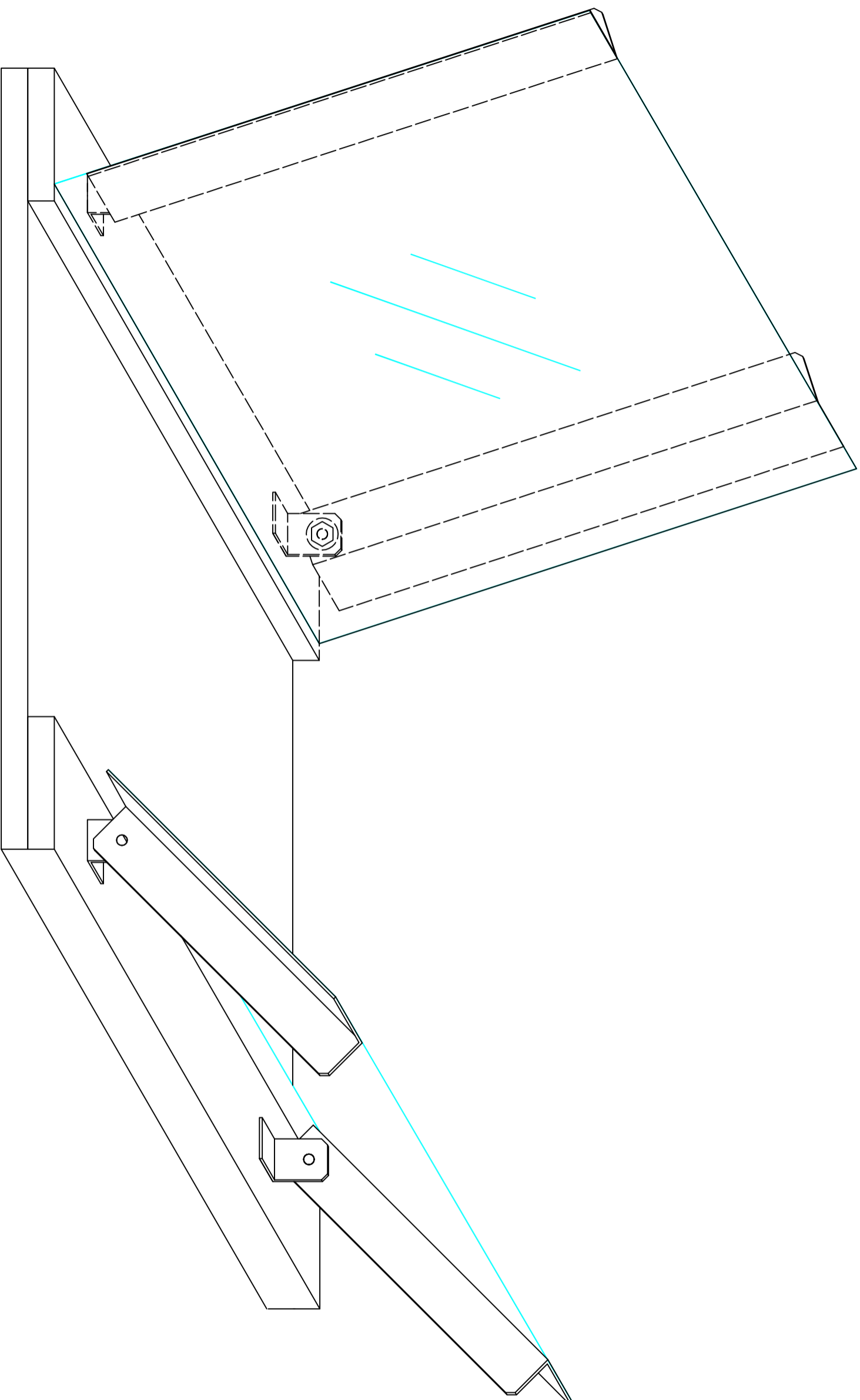

NEWTON SOLAR OVEN 2

COPYRIGHT BY MATTEO MUCCIOLI, RIMINI, ITALY, 09/08/2019

FOR INFORMATIONS CONTACT AT matteo.muccioli@gmail.com or FACEBOOK PAGE "STUDIO MUMALAB" or "MATTEO MUCCIOLI"

SOLAR BOX MADE ENTIRELY IN GLASS, PAY IMPORTANT ATTENTION: USERS ASSUMES ALL RISKS.

USE ALL SAFETY SYSTEMS TO PROTECT THE EYES AND THE REST OF THE BODY. DO NOT OPERATE IN WIND CONDITIONS.

DO NOT LEAVE UNSUPERVISED. WEAR SUNGLASSES OR DARKER EYE PROTECTION

I AM NOT RESPONSIBLE FOR AN IMPROPER USE

NEWTON SOLAR OVEN 2: EXAMPLE OF USE

DO NOT PLACE THE THERMAL MASS DIRECTLY ON THE LOWER GLASS. USE A LOWER WOODEN OR CARDBOARD INSULATION.

